

**1200X2400mm**

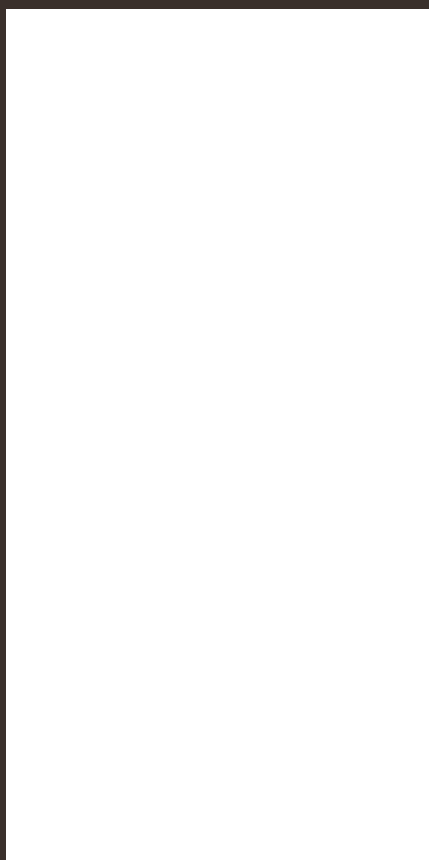

COLLECTION **2019**

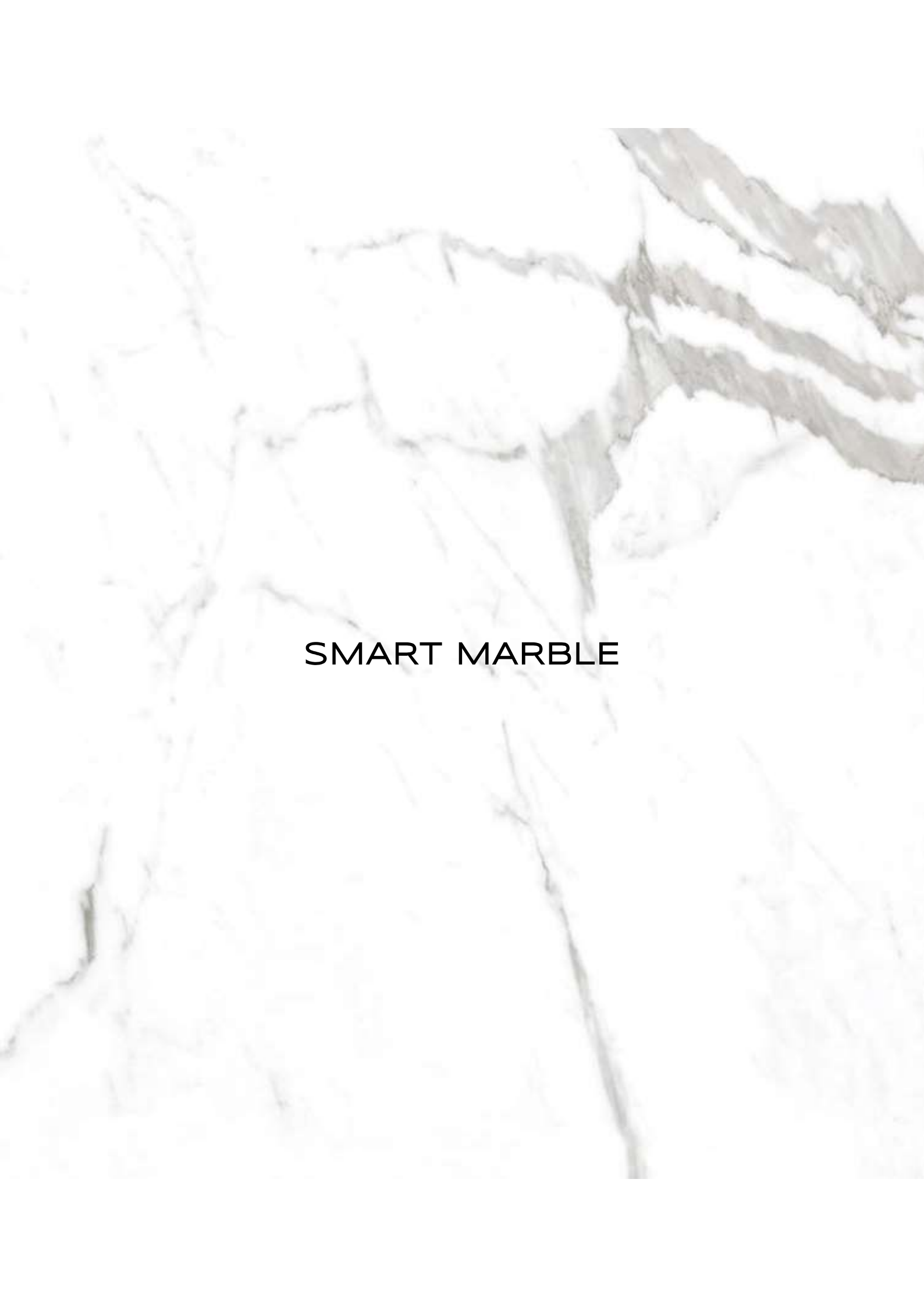



**SMART MARBLE**

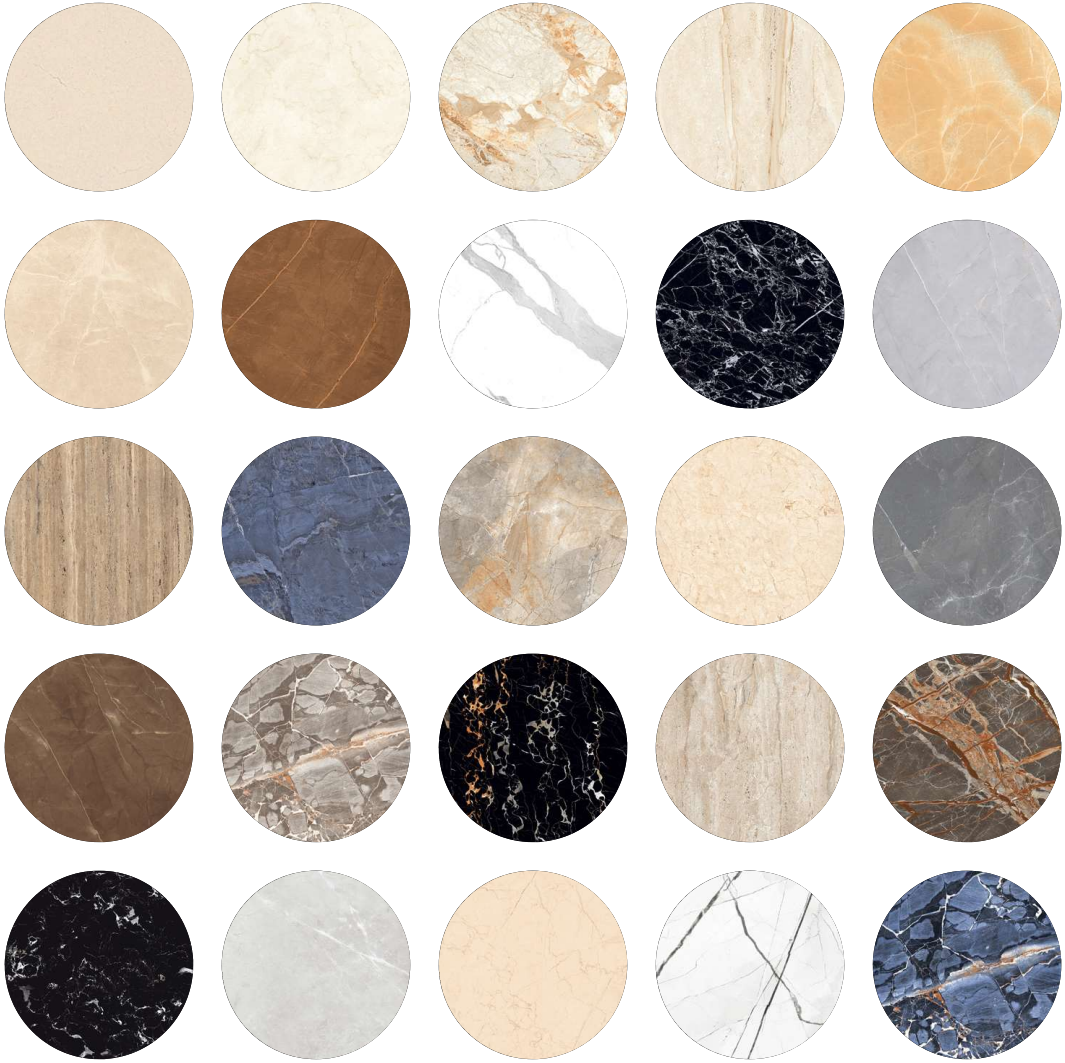

Smart Marble is a flourishing centre for Italian design and slabs. Smart Marble is a new conglomerate that offers a rich array of products and services in terms of design and manufacturing of slabs. Smart Marble represents unparalleled technical, artistic and organizational standards that distinguish it from its peers.

Smart Marble is the essence of years of rigorous research. In its core efforts, Smart Marble epitomizes the urge to establish new standards and norms in the industry. Over decades of experience has gone into the making of this ambitious venture that we set to revolutionize art and craft of manufacturing slabs. Based on ground-breaking research, Smart Marble has conceptualized its ravishing designs and world-class manufacturing process.





## WHAT IS **SMART MARBLE?**

---

**STRENGTH PLUS  
LIGHTNESS,  
VERY LARG SIZES  
AND LOW THICKNESS.**

An innovative and Italian quality porcelain slabs, ideal for kitchen countertops, bathroom countertops, furniture, flooring and wall applications. The perfect combination of quality and wide collections of texture surface like marble, stone, wood, metal & concrete.

><  
6 MM  
0.24"

><  
9 MM  
0.36"





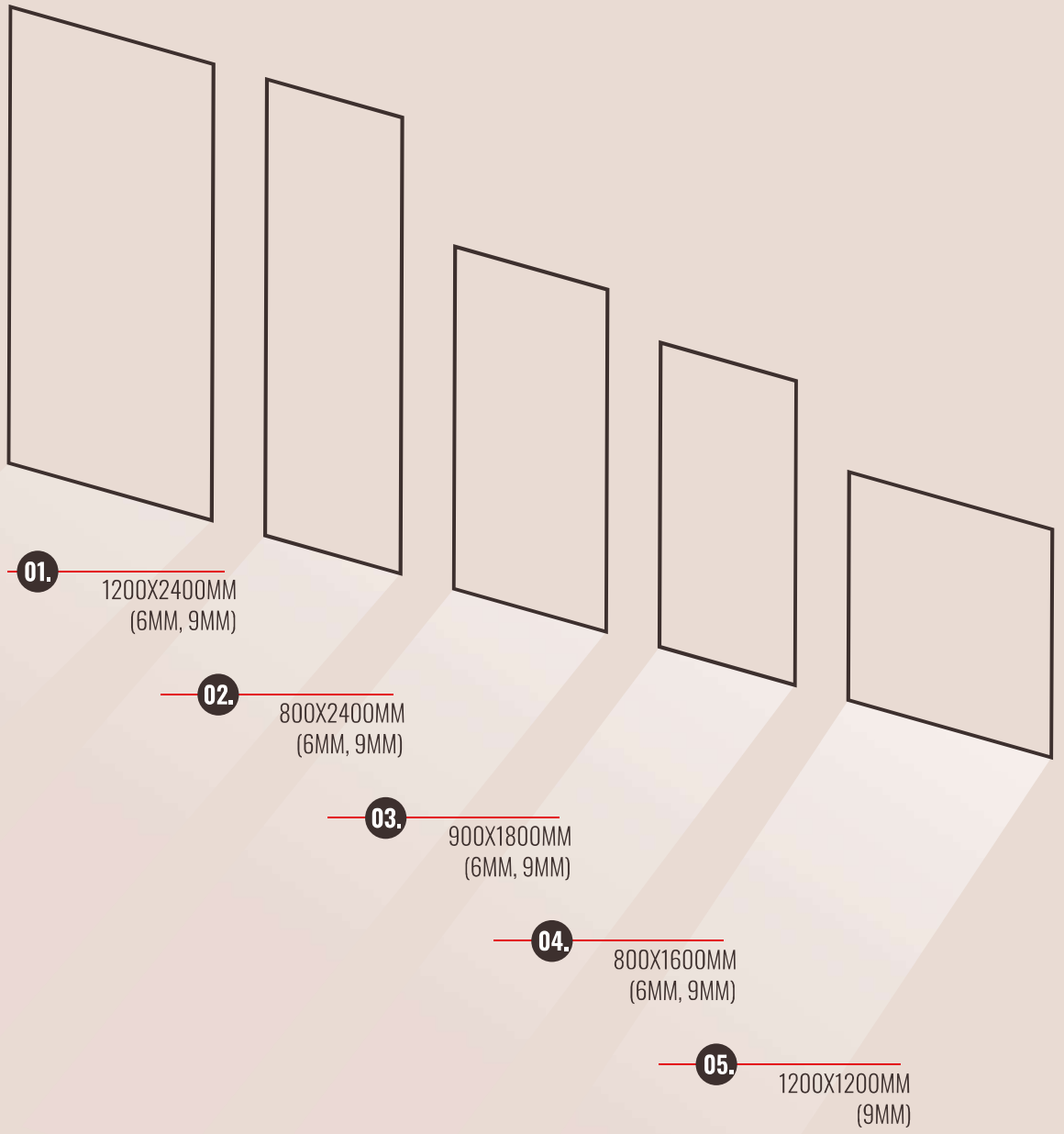

Specific answers to any need.  
**5 sizes, 2 thickness options**

## APPLICATION



AIRPORT



RESTAURANT



FITTED KITCHEN AND  
BATHROOM FURNITURE



HOTELS



RETAIL MALLS



SPA AND WELLNESS  
CENTRES



OFFICES



SHOPS



MUSEUMS



VENTILATED CURTAIN  
WALLS



HOMES



INTERIOR DESIGN  
AND FURNISHINGS

## NEW PRODUCTION TECHNOLOGIES BRING UP THE CHALLENGE OF CREATING MATERIALS CAPABLE OF SHAPING THE SPACE TECHNICALLY AND ESTHETICLY IN AN EFFICIENT WAY.

Smart Marble, a brand born to provide advanced solutions to architecture and interior design. Materials that offer unlimited versatility in all fields of construction, furniture, design, etc.

## FEATURES



HIGHLY UV  
RESISTANT



RESISTANT TO  
SCRATCHES



WATERPROOF



RESISTANCE TO  
CHEMICAL ATTACK



LIGHTNESS



LIGHTNESS



FROST  
RESISTANCE



RESISTANT TO  
STAINS



RECYCLABLE



EASY TO CLEAN



FIREPROOF

# POSSIBILITIES

---

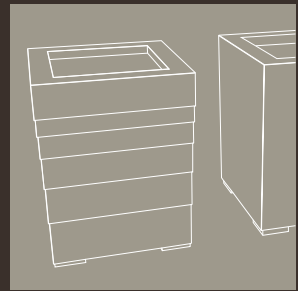
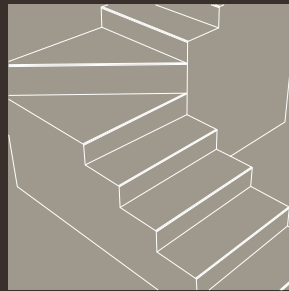
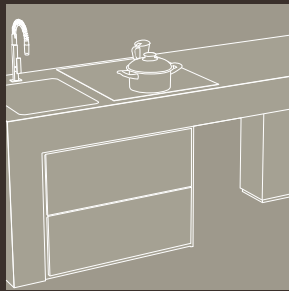
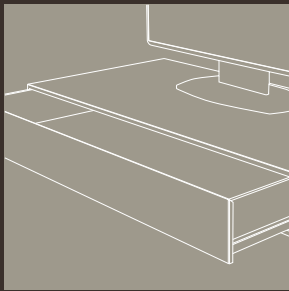
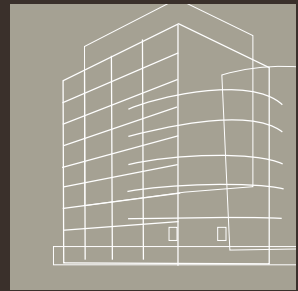
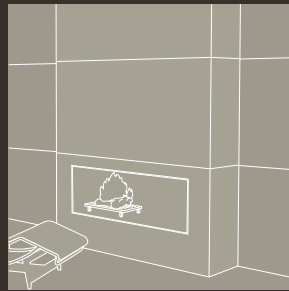
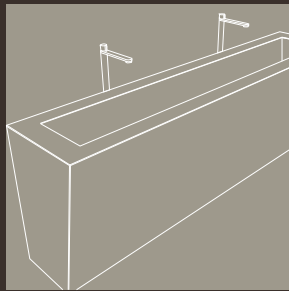
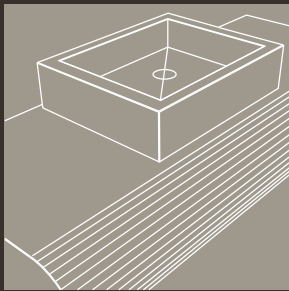
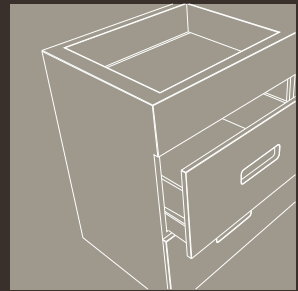
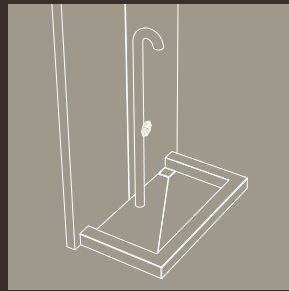
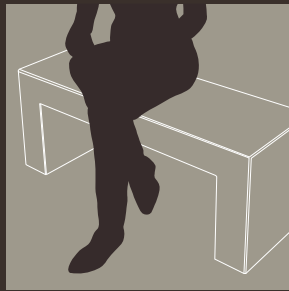
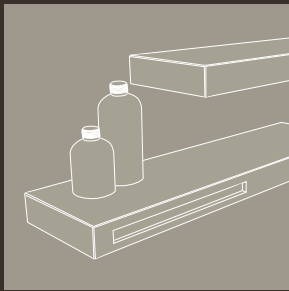

**ORIGINALITY  
IS MUST.**



## VISIONARY DESIGN

Smart Marble is the perfect combination of visionary design and technological performance, a creative partner anywhere in the world for any type of architectural project requiring distinction through unique, recognizable style.

## INNOVATION FOR TOP ARCHITECTURE

Smart Marble stands for innovation that elevates architecture to a rare art form. It leverages design features in such a fashion that architects are able to unleash their creativity and give shape to spaces in an unhindered way. Ibis provides unparalleled innovation quotient for architecture to flourish.

## INDUSTRIAL EXPERTISE FOR TECHNICAL PERFECTION

From inception of an idea to manufacturing it to perfection, Ibis possesses staggering industrial expertise for technical excellence. At Ibis, excellence is the only standard that we maintain.

## INSPIRING DESIGNERS

The visionary design philosophy propels us towards the consortium of designers who are looking to push the frontiers of design. We collaborate with designers of international repute and provide the impetus for their design aspirations.

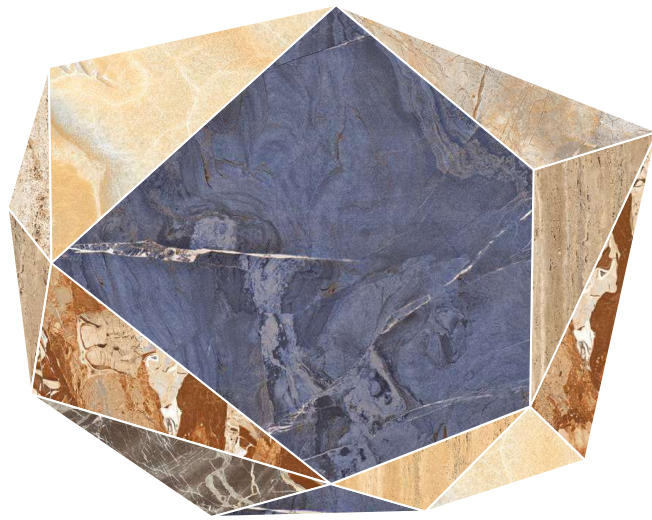

FINISH



**GLOSSY**



Different tones of cream, in line with warmer personalities. You can have beautiful spaces that embrace and create a home. We have marbles with great decorative possibilities that never fail. Some are calmer, other are more innovative. They are all beautiful and create a great range of radiant begies that shine with their own light.

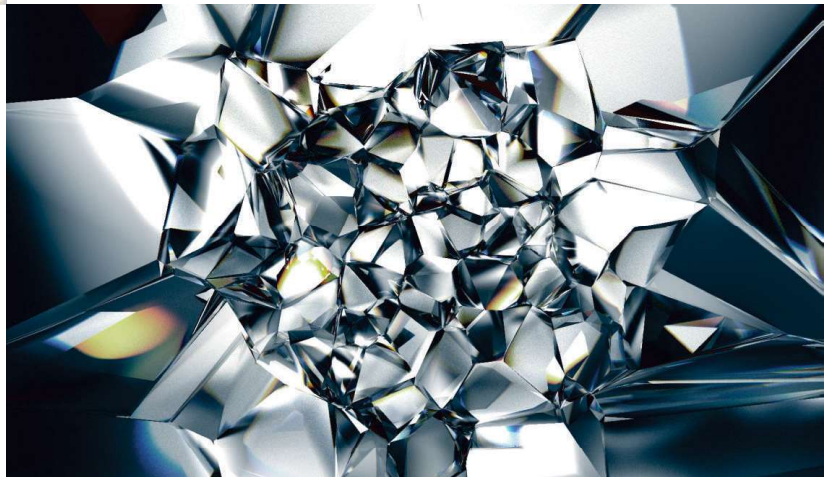

**ALLURE**

**RANDOM**

2



**ANTRESIT BEIGE**

**RANDOM**

3



**THICKNESS**

**6MM, 9 MM  
15MM, 18MM**

**SIZE**

**1200X2400MM**

**FINISH**

**GLOSSY**

**EFFECT**

**MARBLE**



**ANTRESIT BIANCO**

**RANDOM**

**3**



**ANTRESIT GREY**

**RANDOM**

**3**



**THICKNESS**

**6MM, 9 MM  
15MM, 18MM**

**SIZE**

**1200X2400MM**

**FINISH**

**GLOSSY**

**EFFECT**

**MARBLE**

ICEY BROWN

RANDOM

7



THICKNESS

6MM, 9 MM  
15MM, 18MM

SIZE

1200X2400MM

FINISH

GLOSSY

EFFECT

MARBLE



**ICEY GREY**

**RANDOM**

**7**



**THICKNESS**

**6MM, 9 MM  
15MM, 18MM**

**SIZE**

**1200X2400MM**

**FINISH**

**GLOSSY**

**EFFECT**

**MARBLE**



**BALVAGIRI BEIGE**

RANDOM

2



**BELVEDRE PELLE**

RANDOM

2



THICKNESS

6MM, 9 MM  
15MM, 18MM

SIZE

1200X2400MM

FINISH

GLOSSY

EFFECT

MARBLE

**BIANCO STATUARIO  
VENATO**

RANDOM

4

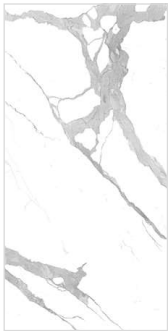
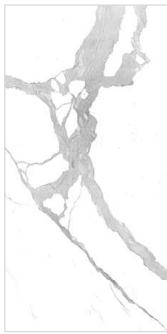
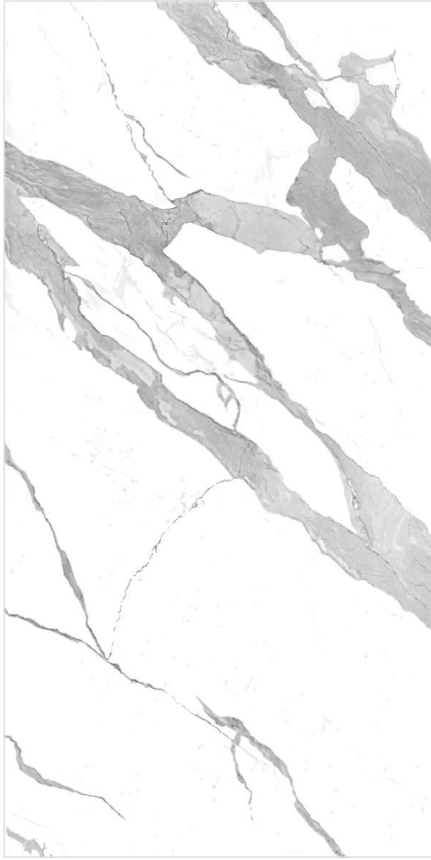

**BLACK BEAUTY**

RANDOM

2

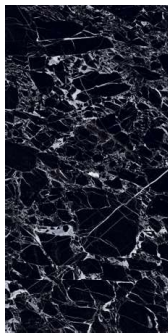
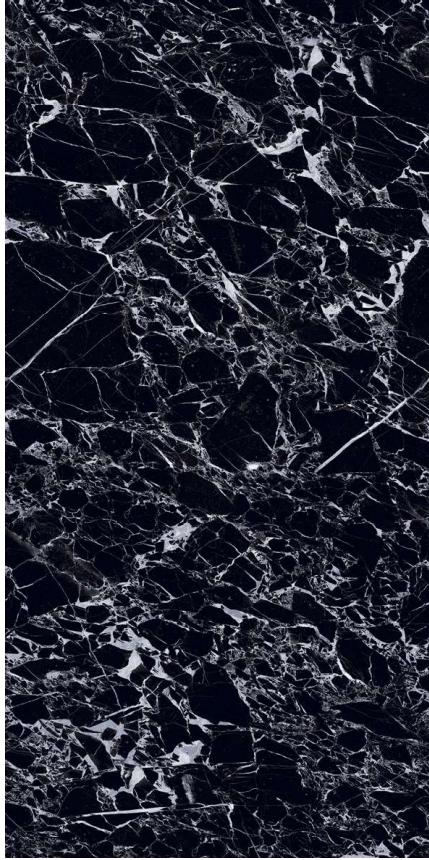

THICKNESS

6MM, 9 MM  
15MM, 18MM

SIZE

1200X2400MM

FINISH

GLOSSY

EFFECT

MARBLE

**BLACK PEARL**

**RANDOM**

6

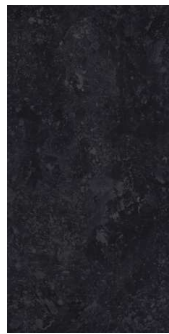

**THICKNESS**

**6MM, 9 MM  
15MM, 18MM**

**SIZE**

**1200X2400MM**

**FINISH**

**GLOSSY**

**EFFECT**

**MARBLE**

**BLUE PRECIOUS WOOD**

RANDOM

1

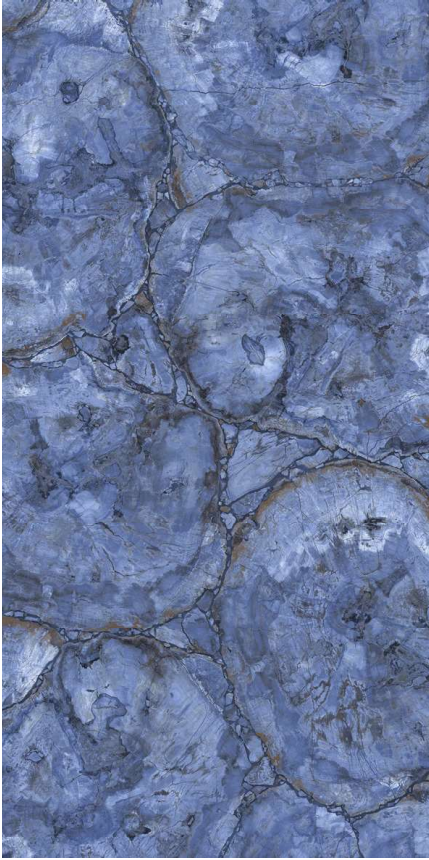

**BOTTOCHINO CLASSICO  
BEIGE**

RANDOM

5



THICKNESS

6MM, 9 MM  
15MM, 18MM

SIZE

1200X2400MM

FINISH

GLOSSY

EFFECT

MARBLE



**BOTTOCINO FIORTO**

RANDOM

3



**BRECCIA AURORA**

RANDOM

3



THICKNESS

6MM, 9 MM  
15MM, 18MM

SIZE

1200X2400MM

FINISH

GLOSSY

EFFECT

MARBLE



**BRECCIA BEIGE**

RANDOM

3



**CALACATTA**

RANDOM

2



THICKNESS

6MM, 9 MM  
15MM, 18MM

SIZE

1200X2400MM

FINISH

GLOSSY

EFFECT

MARBLE

**CARACUS GREY**

**RANDOM**

1

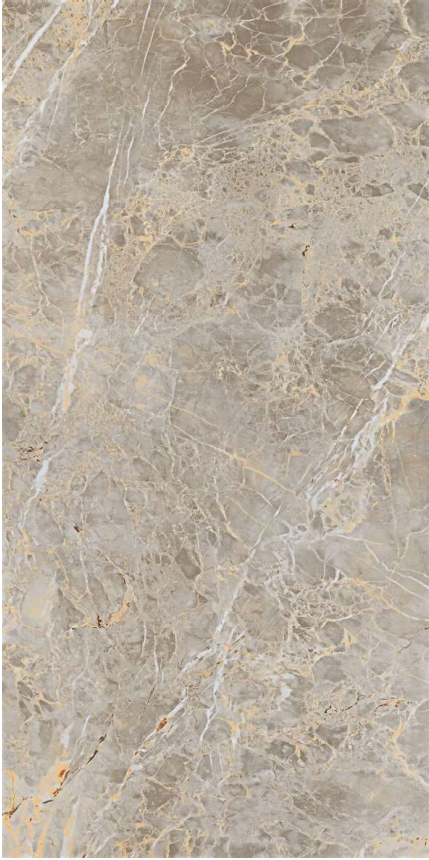

**CARRARA BORGHINI**

**RANDOM**

4



**THICKNESS**

**6MM, 9 MM  
15MM, 18MM**

**SIZE**

**1200X2400MM**

**FINISH**

**GLOSSY**

**EFFECT**

**MARBLE**

CASA BLANCA

RANDOM

2



COSMOS

RANDOM

2



THICKNESS

6MM, 9 MM  
15MM, 18MM

SIZE

1200X2400MM

FINISH

GLOSSY

EFFECT

MARBLE

**CREMA MARFIL**

**RANDOM**

**3**



**CRYSTAL ONICO**

**RANDOM**

**2**



**THICKNESS**

**6MM, 9 MM  
15MM, 18MM**

**SIZE**

**1200X2400MM**

**FINISH**

**GLOSSY**

**EFFECT**

**MARBLE**

**DYNA NATURAL**

**RANDOM**

5



**EMPERADOR MARRON**

**RANDOM**

2

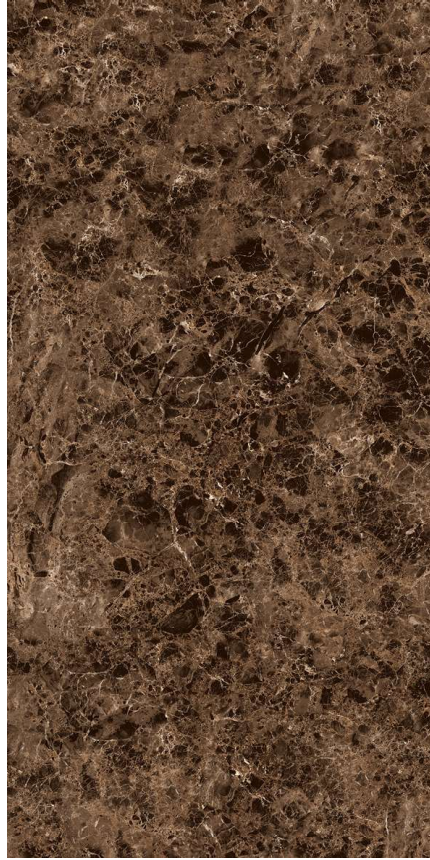

**THICKNESS**

**6MM, 9 MM  
15MM, 18MM**

**SIZE**

**1200X2400MM**

**FINISH**

**GLOSSY**

**EFFECT**

**MARBLE**



EMPERADOR QUARTZ

RANDOM

2

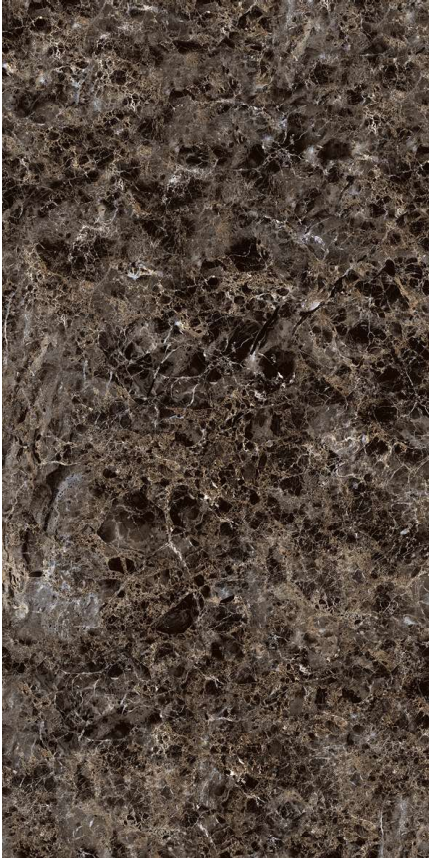

EXOTIC TAJ BOOK MATCH

RANDOM

2



THICKNESS

6MM, 9 MM  
15MM, 18MM

SIZE

1200X2400MM

FINISH

GLOSSY

EFFECT

MARBLE

**FLORENCE WHITE**

**RANDOM**

**3**

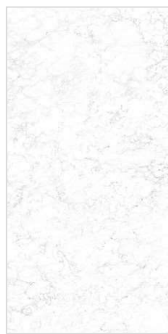

**FRENCH PORCELAIN**

**RANDOM**

**2**



**THICKNESS**

**6MM, 9 MM  
15MM, 18MM**

**SIZE**

**1200X2400MM**

**FINISH**

**GLOSSY**

**EFFECT**

**MARBLE**

**FRENCH SILVER**

**RANDOM**

**2**



**GREY MILANO**

**RANDOM**

**2**



**THICKNESS**

**6MM, 9 MM  
15MM, 18MM**

**SIZE**

**1200X2400MM**

**FINISH**

**GLOSSY**

**EFFECT**

**MARBLE**



**LAVA SATATUARIO**

**RANDOM**

**3**

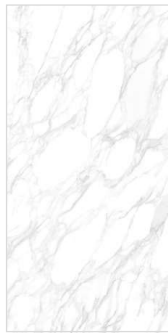

**LORENZ CREMA**

**RANDOM**

**2**



**THICKNESS**

**6MM, 9 MM  
15MM, 18MM**

**SIZE**

**1200X2400MM**

**FINISH**

**GLOSSY**

**EFFECT**

**MARBLE**

**LORENZ WHITE**

**RANDOM**

**2**



**LOURENT GOLD**

**RANDOM**

**2**

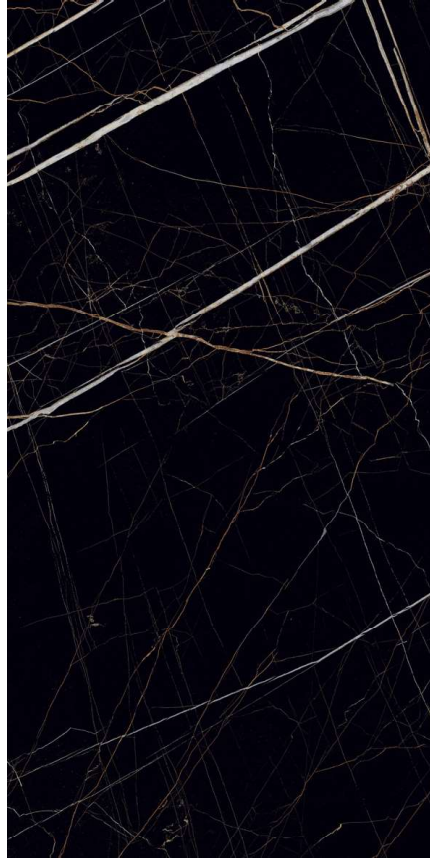

**THICKNESS**

**6MM, 9 MM  
15MM, 18MM**

**SIZE**

**1200X2400MM**

**FINISH**

**GLOSSY**

**EFFECT**

**MARBLE**

**MARFIL BEIGE**

**RANDOM**

**3**



**NOIR DESIRLUCIDATO**

**RANDOM**

**4**



**THICKNESS**

**6MM, 9 MM  
15MM, 18MM**

**SIZE**

**1200X2400MM**

**FINISH**

**GLOSSY**

**EFFECT**

**MARBLE**

**NOVELLE CREMA**

**RANDOM**

**2**



**NOVELLE ICE**

**RANDOM**

**2**



**THICKNESS**

**6MM, 9 MM  
15MM, 18MM**

**SIZE**

**1200X2400MM**

**FINISH**

**GLOSSY**

**EFFECT**

**MARBLE**

OCEAN ONYX

RANDOM

2



ORIENT BEIGE

RANDOM

2

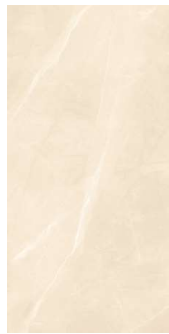

THICKNESS

6MM, 9 MM  
15MM, 18MM

SIZE

1200X2400MM

FINISH

GLOSSY

EFFECT

MARBLE

**ORIENT BROWN**

**RANDOM**

2



**OROBICO GREY**

**RANDOM**

2



**THICKNESS**

**6MM, 9 MM  
15MM, 18MM**

**SIZE**

**1200X2400MM**

**FINISH**

**GLOSSY**

**EFFECT**

**MARBLE**

**PIETRA GREYLUCIDATO**

RANDOM

4



**PRECIOUS WOOD**

RANDOM

1



THICKNESS

6MM, 9 MM  
15MM, 18MM

SIZE

1200X2400MM

FINISH

GLOSSY

EFFECT

MARBLE

ROSE BLACK

RANDOM

4



SAPPHIRE GRAY

RANDOM

3

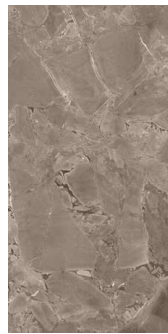
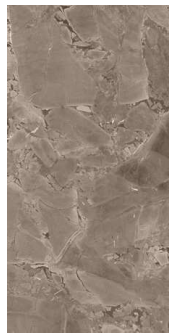

THICKNESS

6MM, 9 MM  
15MM, 18MM

SIZE

1200X2400MM

FINISH

GLOSSY

EFFECT

MARBLE



**SATUARIO FANTASTICO**

**RANDOM**

2



**SATUARIO PEARL**

**RANDOM**

3



**THICKNESS**

**6MM, 9 MM  
15MM, 18MM**

**SIZE**

**1200X2400MM**

**FINISH**

**GLOSSY**

**EFFECT**

**MARBLE**

**SMOKE GREY**

**RANDOM**

**2**



**STATUARIO ICE**

**RANDOM**

**3**



**THICKNESS**

**6MM, 9 MM  
15MM, 18MM**

**SIZE**

**1200X2400MM**

**FINISH**

**GLOSSY**

**EFFECT**

**MARBLE**

**STATUARIO LUCIDATO**

**RANDOM**

6

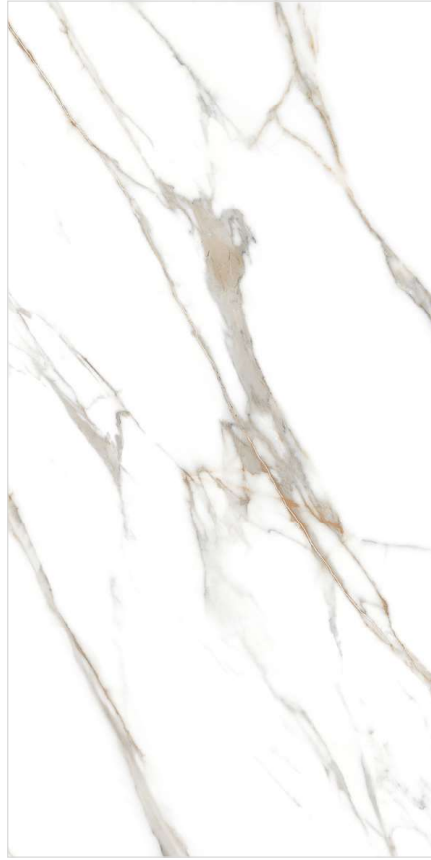
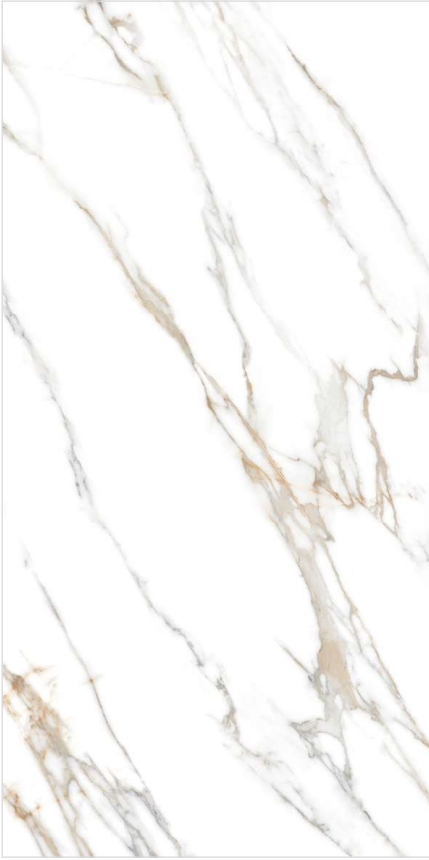

**THICKNESS**

**6MM, 9 MM  
15MM, 18MM**

**SIZE**

**1200X2400MM**

**FINISH**

**GLOSSY**

**EFFECT**

**MARBLE**

**STATUARIO SUPER**

**RANDOM**

**2**



**WHITE ONYX**

**RANDOM**

**2**



**THICKNESS**

**6MM, 9 MM  
15MM, 18MM**

**SIZE**

**1200X2400MM**

**FINISH**

**GLOSSY**

**EFFECT**

**MARBLE**

ARMANI VIGARIO

RANDOM

8



THICKNESS

6MM, 9 MM  
15MM, 18MM

SIZE

1200X2400MM

FINISH

GLOSSY

EFFECT

MARBLE



CALACATTA ELITE

RANDOM

8



THICKNESS

6MM, 9 MM  
15MM, 18MM

SIZE

1200X2400MM

FINISH

GLOSSY

EFFECT

MARBLE



**BLACK SYMPHONY**

**RANDOM**

8

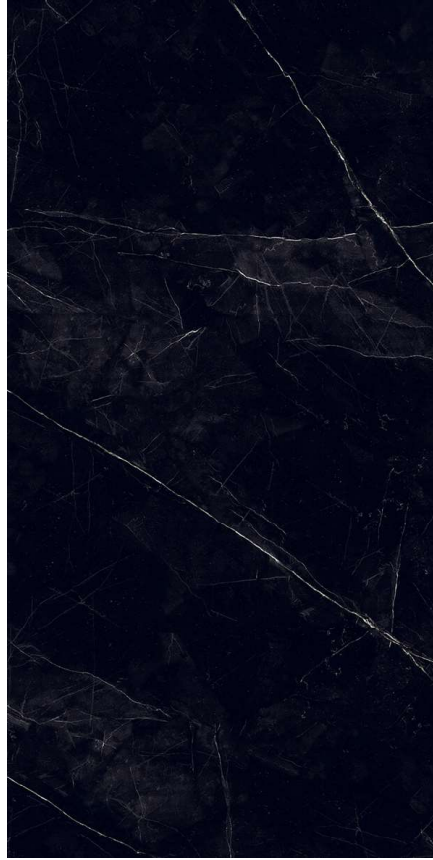

**THICKNESS**

**6MM, 9 MM  
15MM, 18MM**

**SIZE**

**1200X2400MM**

**FINISH**

**GLOSSY**

**EFFECT**

**MARBLE**



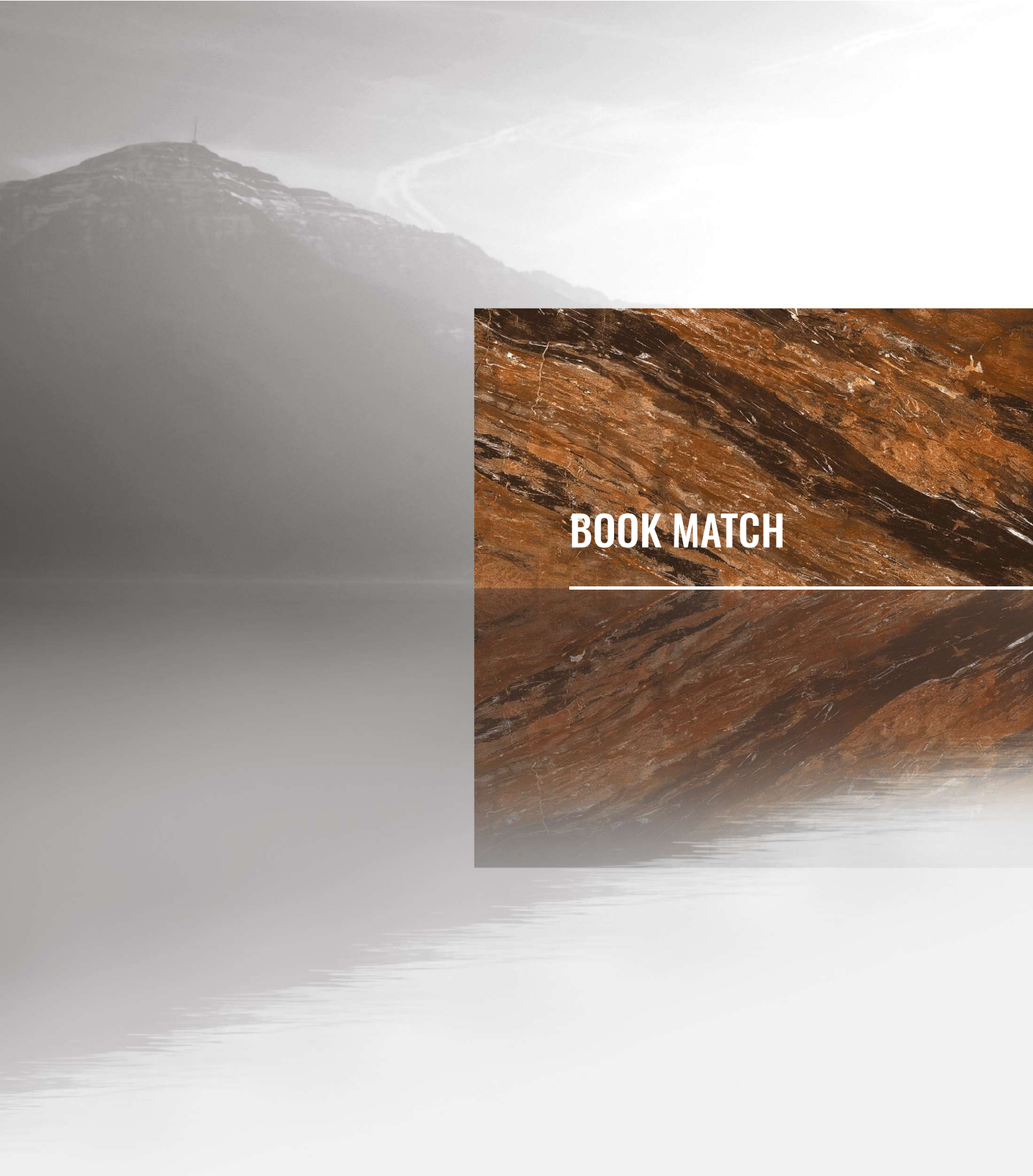

**BOOK MATCH**

---





ARMANI GOLD BOOK MATCH

RANDOM

2



A



B

THICKNESS

6MM, 9 MM  
15MM, 18MM

SIZE

1200X2400MM

FINISH

GLOSSY

EFFECT

MARBLE

ARMANI GREY NEW BOOK MATCH

RANDOM

2



A



B

THICKNESS

6MM, 9 MM  
15MM, 18MM

SIZE

1200X2400MM

FINISH

GLOSSY

EFFECT

MARBLE

**BLUE BRECCIA BOOK MATCH**

**RANDOM**

2



A



B

**THICKNESS**

**6MM, 9 MM  
15MM, 18MM**

**SIZE**

**1200X2400MM**

**FINISH**

**GLOSSY**

**EFFECT**

**MARBLE**

**BRECCIA AURORA BOOK MATCH**

**RANDOM**

2



A



B

**THICKNESS**

**6MM, 9 MM  
15MM, 18MM**

**SIZE**

**1200X2400MM**

**FINISH**

**GLOSSY**

**EFFECT**

**MARBLE**

**BRECCIA CLASSIC BOOK MATCH**

**RANDOM**

2



A



B

**THICKNESS**

**6MM, 9 MM  
15MM, 18MM**

**SIZE**

**1200X2400MM**

**FINISH**

**GLOSSY**

**EFFECT**

**MARBLE**

**CALCATA BORGHINI BOOK MATCH**

**RANDOM**

2



A



B

**THICKNESS**

**6MM, 9 MM  
15MM, 18MM**

**SIZE**

**1200X2400MM**

**FINISH**

**GLOSSY**

**EFFECT**

**MARBLE**

COSMOS BOOK MATCH

RANDOM

2



A



B

THICKNESS

6MM, 9 MM  
15MM, 18MM

SIZE

1200X2400MM

FINISH

GLOSSY

EFFECT

MARBLE



EXOTIC TAJ BOOK MATCH

RANDOM

2



A



B

THICKNESS

6MM, 9 MM  
15MM, 18MM

SIZE

1200X2400MM

FINISH

GLOSSY

EFFECT

MARBLE

SATUARIO PEARL BOOK MATCH

RANDOM

2

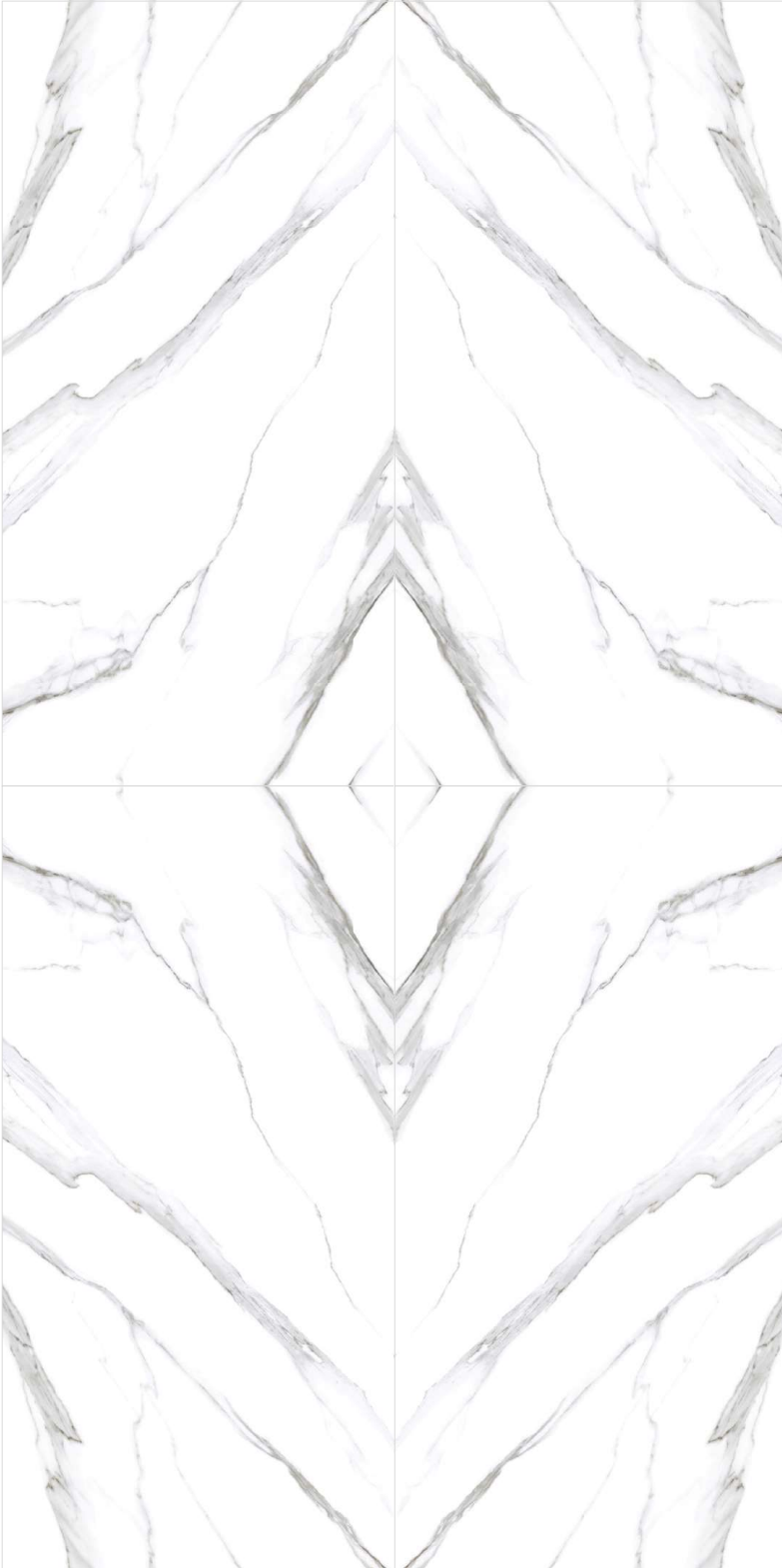

A



B

THICKNESS

6MM, 9 MM  
15MM, 18MM

SIZE

1200X2400MM

FINISH

GLOSSY

EFFECT

MARBLE

STATUARIO CLASSIC BOOK MATCH

RANDOM

2



A



B

THICKNESS

6MM, 9MM  
15MM, 18MM

SIZE

1200X2400MM

FINISH

GLOSSY

EFFECT

MARBLE

STATUARIO ITALIA BOOK MATCH

RANDOM

2

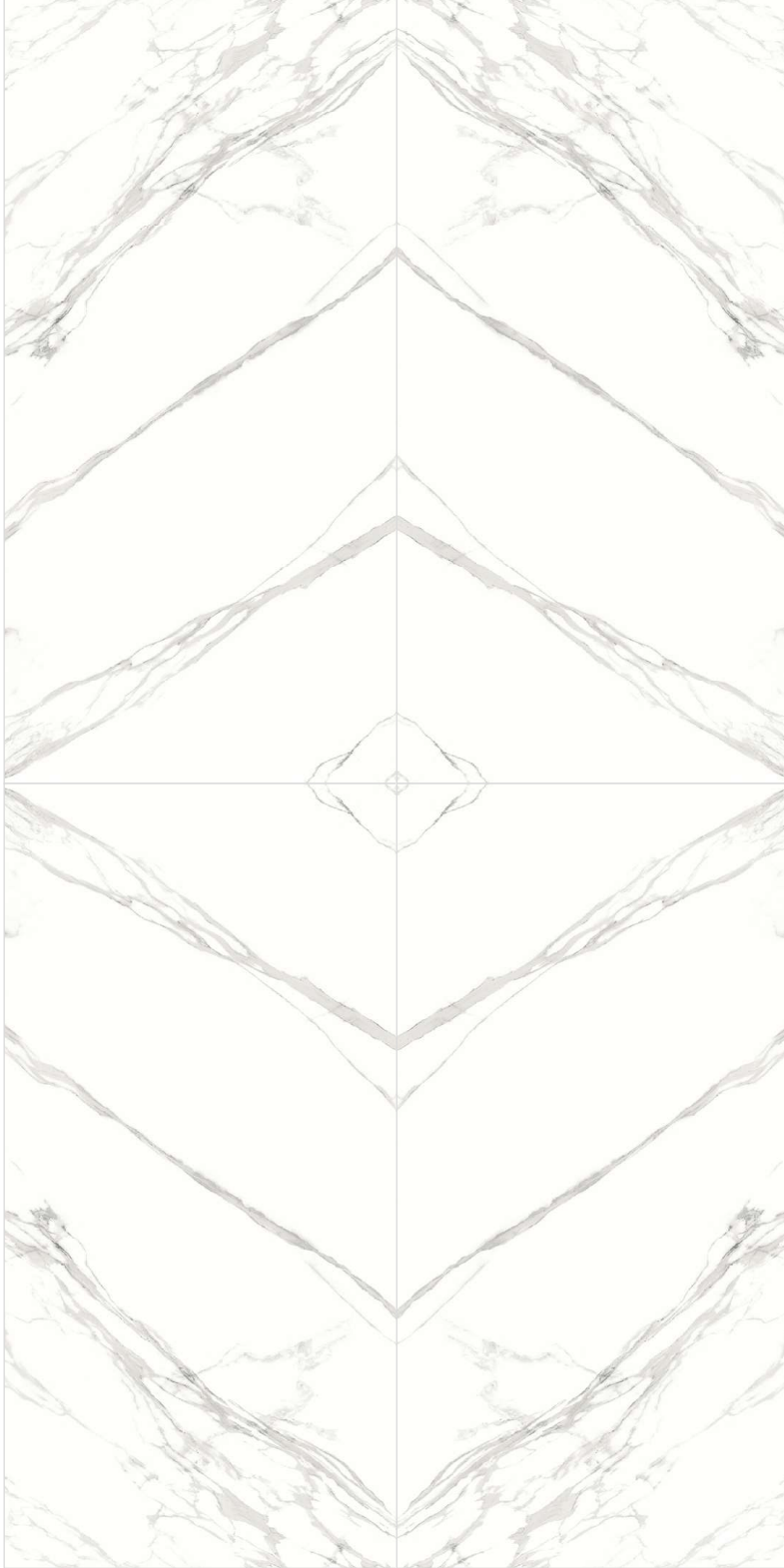

A



B

THICKNESS

6MM, 9 MM  
15MM, 18MM

SIZE

1200X2400MM

FINISH

GLOSSY

EFFECT

MARBLE

STATUARIO LUCIDATO BOOK MATCH

RANDOM

2



A



B

THICKNESS

6MM, 9MM  
15MM, 18MM

SIZE

1200X2400MM

FINISH

GLOSSY

EFFECT

MARBLE

MODERN SATUARIO BOOK MATCH

RANDOM

2

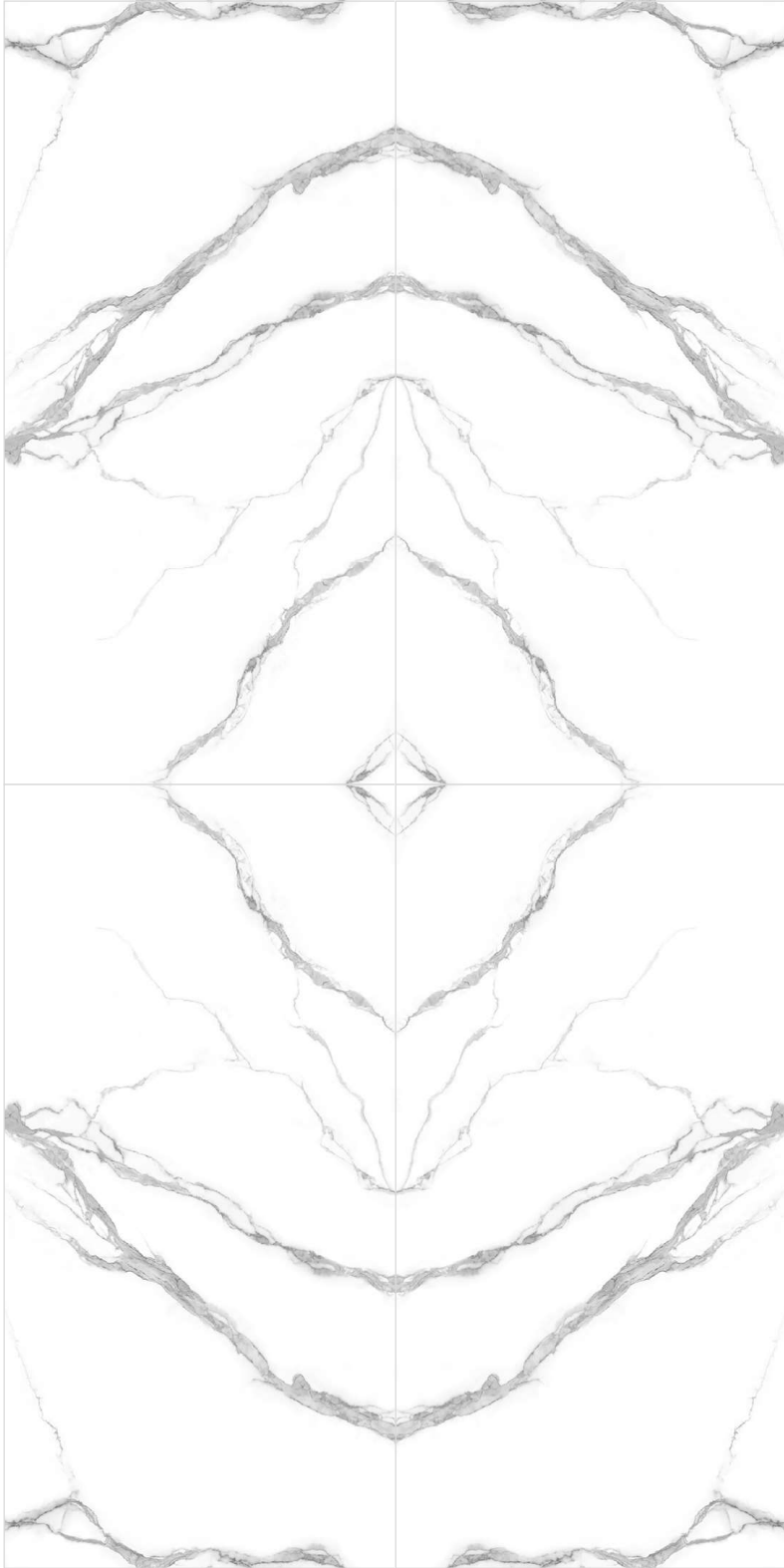

A



B

THICKNESS

6MM, 9 MM  
15MM, 18MM

SIZE

1200X2400MM

FINISH

GLOSSY

EFFECT

MARBLE





FINISH



**MATT**





Scintillating and yet serene.  
These marbles encompass the core of style,  
finest and majesty.



**CARMEL BEIGE**

**RANDOM**

**2**



**CARMEL BIANCO**

**RANDOM**

**2**



**THICKNESS**

**6MM, 9 MM  
15MM, 18MM**

**SIZE**

**1200X2400MM**

**FINISH**

**MATT**

**EFFECT**

**MARBLE**

**CARMEL GREY**

**RANDOM**

2



**FOSSIL GREY**

**RANDOM**

3

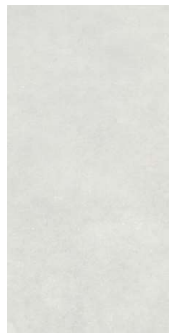
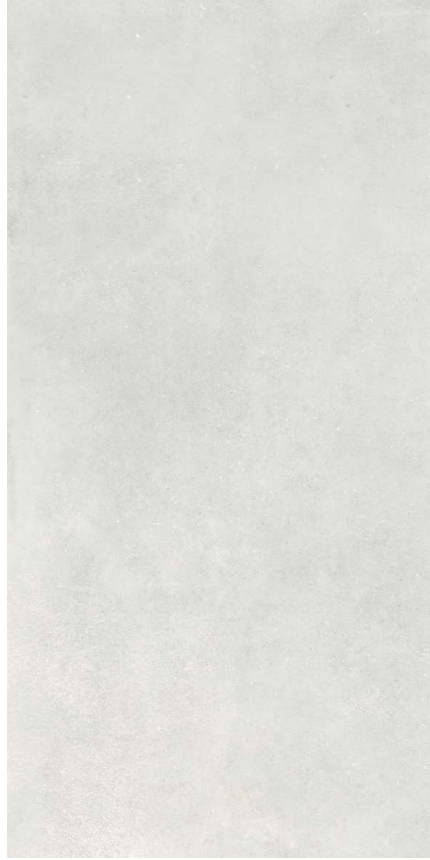

**THICKNESS**

**6MM, 9 MM  
15MM, 18MM**

**SIZE**

**1200X2400MM**

**FINISH**

**MATT**

**EFFECT**

**MARBLE**

**FUSION WOOD GREYV**

**RANDOM**

**2**



**MEGA BROWN**

**RANDOM**

**2**



**THICKNESS**

**6MM, 9 MM  
15MM, 18MM**

**SIZE**

**1200X2400MM**

**FINISH**

**MATT**

**EFFECT**

**MARBLE**

**MEGA CEMENTO**

**RANDOM**

**2**



**MEGA SAND**

**RANDOM**

**2**



**THICKNESS**

**6MM, 9 MM  
15MM, 18MM**

**SIZE**

**1200X2400MM**

**FINISH**

**MATT**

**EFFECT**

**MARBLE**

**NOIR DESIR**

**RANDOM**

4



**OXIDE EARTH**

**RANDOM**

3



**THICKNESS**

**6MM, 9 MM  
15MM, 18MM**

**SIZE**

**1200X2400MM**

**FINISH**

**MATT**

**EFFECT**

**MARBLE**

**—**  
QUITE MIST

RANDOM **—**

2



**—**  
QUITE ANTHRACITE

RANDOM **—**

2



THICKNESS

**—**  
6MM, 9 MM  
15MM, 18MM

SIZE

**—**  
1200X2400MM

FINISH

**—**  
MATT

EFFECT

**—**  
MARBLE

**QUITE ASH**

**RANDOM**

2



**QUITE BROWN**

**RANDOM**

2



**THICKNESS**

**6MM, 9 MM  
15MM, 18MM**

**SIZE**

**1200X2400MM**

**FINISH**

**MATT**

**EFFECT**

**MARBLE**



**TREDI BIANCO**

RANDOM

1

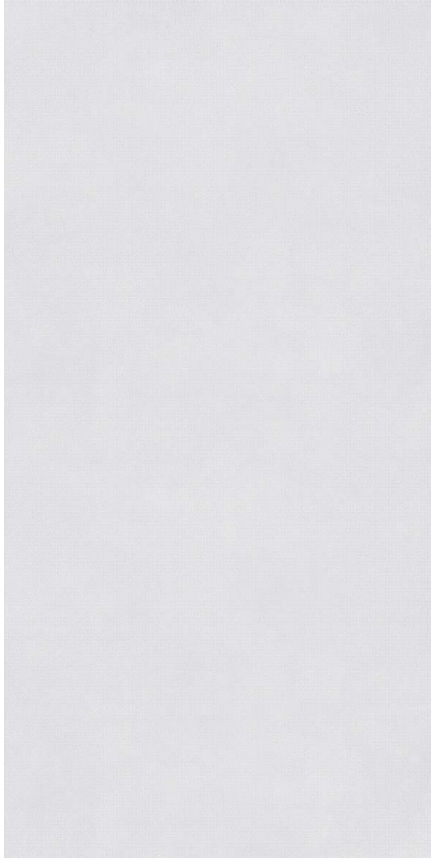

**TREDI BROWN**

RANDOM

1

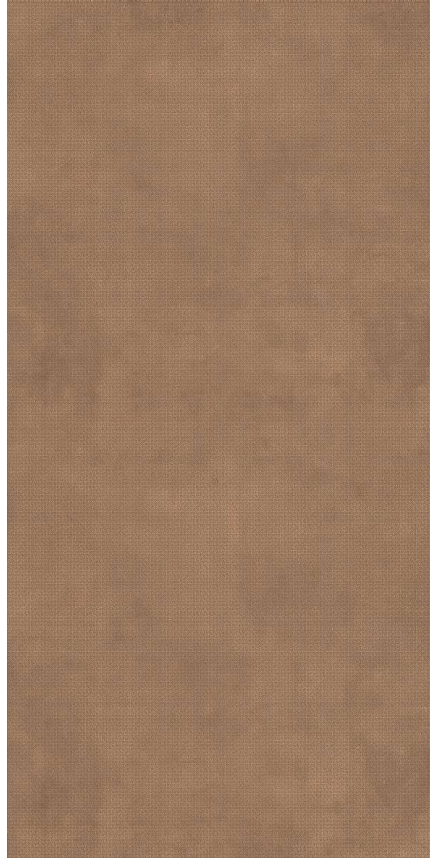

THICKNESS

6MM, 9 MM  
15MM, 18MM

SIZE

1200X2400MM

FINISH

MATT

EFFECT

MARBLE

**TREDI GREY**

**RANDOM**

1

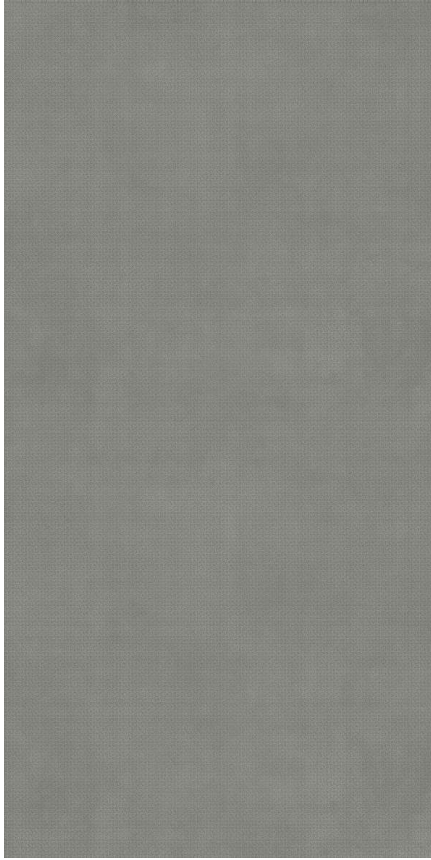

**URBAN GREY**

**RANDOM**

3

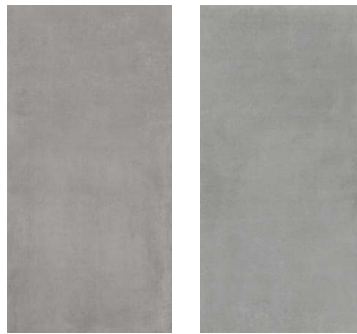
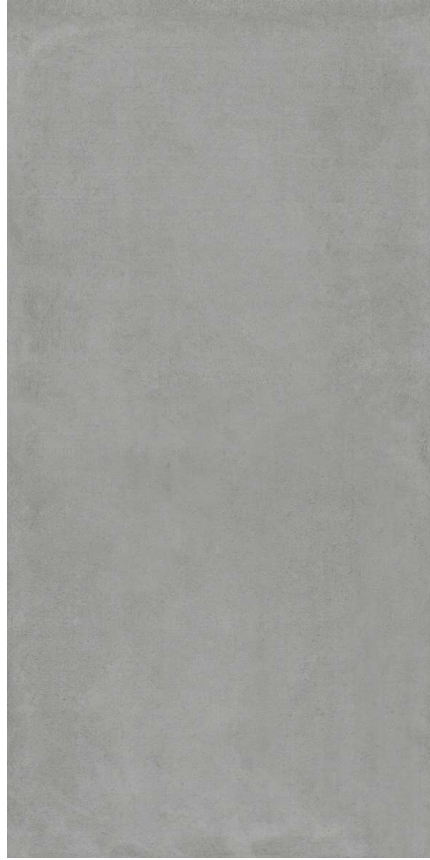

**THICKNESS**

**6MM, 9 MM  
15MM, 18MM**

**SIZE**

**1200X2400MM**

**FINISH**

**MATT**

**EFFECT**

**MARBLE**



# TECHNICAL SPECIFICATION

CHARACTERISTICS	STANDARD AS PER ISO-13006/En14411 GROUP	VALUES	TEST METHOD
-----------------	---	--------	-------------

## REGULATORY PROPERTIES

Deviation in Lenth & Width	0.50%	0.20%	ISO - 10545-2
Deviation in Thickness	0.50%	0.50%	ISO - 10545-2
Straightness of Sides	0.50%	0.20%	ISO - 10545-2
Rectangularity	0.50%	0.20%	ISO - 10545-2
Surface Flatness	0.50%	0.20%	ISO - 10545-2
Color Difference	Unaltered	No Change	ISO - 10545-16
Glossiness	As per Mfg.	>90%	Glossmeter

## STRUCTURAL PROPERTIES

Water Absorption	<0.05%	<0.05%	ISO - 10545-3
Apparent Density	>2.00 g/cc	>2.10 g/cc	DIN 51082

## MASSIVE MECHANICAL PROPERTIES

Modulus of Repture	Min 35N/MM2	Min 40N/MM2	ISO - 10545-4
Breaking Strength	Min. 1300 N	Min. 2000 N	ISO - 10545-4
Impact Resistance	As per Mfg.	Min. 0.55	ISO - 10545-5

## SURFACE MECHANICAL PROPERTIES

Surface Abrasion Resistance	As per Mfg.	Min. class 3	ISO - 10545-7
Moh's Hardness	As per Mfg.	Min. class 4	EN 101

## THERMO HYGROMETRIC PROPERTIES

Frost Resistance	No Damage	No Damage	ISO - 10545-12
Thermal Shock Resistance	No Damage	No Damage	ISO - 10545-09
Moisture Expansion	Nil	Nil	ISO - 10545-10
Thermal Expansion	Max 9.0x10 -6	Max 6.5x10 -6	ISO - 10545-08
Crazing Resistance	As per Mfg.	Min 10 Cycle	ISO - 10545-11

## CHEMICAL PROPERTIES

Chemical Resistance	No Damage	No Damage	ISO - 10545-13
Stain Resistance	Resistant	Resistant	ISO - 10545-14

## SAFETY PROPERTIES

Slip Resistance	As per Mfg.	>0.40	ISO - 10545-17
Fire Resistance	As per Mfg.	Fire Proof	N.A.

# PACKING DETAIL

SIZE (in mm)	THICKNESS APPROX	PIECES / PER BOX	COVERAGE AREA IN SQ. FT	BOX WEIGHT ( APPROX. )
1200x2400 MM	6 MM	1	31	42
1200x2400 MM	9 MM	1	31	61

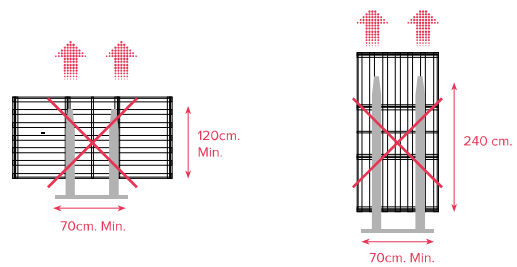
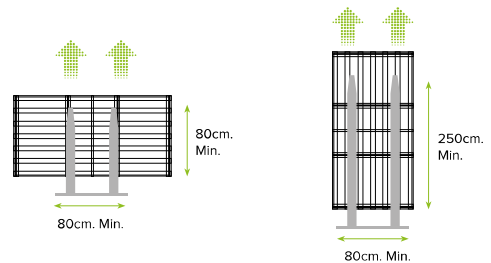
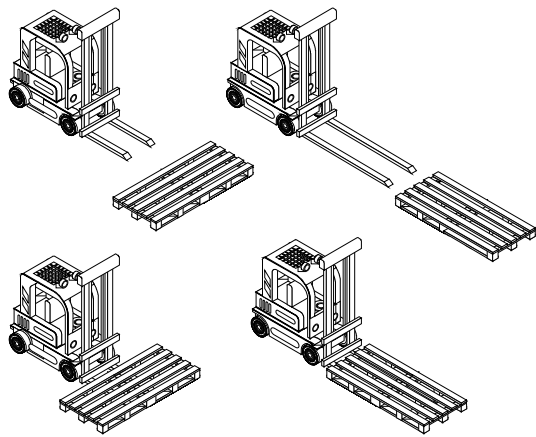

## STORAGE

We should use a forklift truck, at least 2,5 mts. long, with the forks positioned in the largest width position, in order to handle the pallet on a proper way. Under normal conditions, the forks are positioned in the middle of the long side of the pallet, as they must hold the whole depth of the pallet. To allow the extraction of the slabs in a safe and easy way, it is recommended to position the pallets in a suitable area where the lift truck can be moved around all sides of the pallet.

## HANDLING SLAB

IBIS's Extra large format slabs arrive in oversized crates, which require specific handling equipment. To prevent damage from occurring during forklift operation, specific fork sizes must be used. For example, to handle a crate of 135cm x 305cm tiles from the side, 112cm/ 44" long forks are recommended.

To handle the same crate from the narrow end requires forks that are at least 213cm/ 84" long. Lifting multiple crates with longer forks may require forklifts with a greater lift capacity.

Specialised tools and equipment are currently available for the handling and installation of large porcelain surfaces. Innovative trowels with unique notch configurations can help increase the consistency of the mortar coverage on the back of the tile.

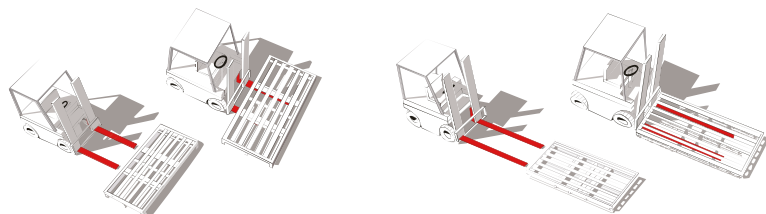

## HANDLING EQUIPMENT

Handling device to free move 150X150 Slabs (use 2 for 305cm Slab)



Double Suction Cup 115 MM



Modular Bench BM 180



## LEVELLING EQUIPMENT

RLS Clips for Tiles 10-12 MM thick (½" - ¾") - 400 pcs bag



Wedges in 1000 pcs / carton

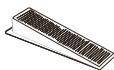

Adjustable pliers for wall and floor covering



## CUTTING EQUIPMENT

Free cut guide with complete outfit Max. cut of length-156 CM



Free cut extension length - 170 CM



Cutting of pillars for tiles/slabs Thickness 6-12 MM



## MECHANICAL FIXING EQUIPMENT

Fix Stainless Steel Hook for 8 MM thickness tiles - 500 pcs



Cut Grooving Machine 850w-230v 50/60hz

