

1200X2400mm



COLLECTION **2019**

The background is a close-up of a marble surface. It features a complex pattern of veins in shades of light beige, cream, and soft brown, set against a lighter, off-white base. The veins are irregular and organic, creating a classic marble aesthetic.

SMART MARBLE

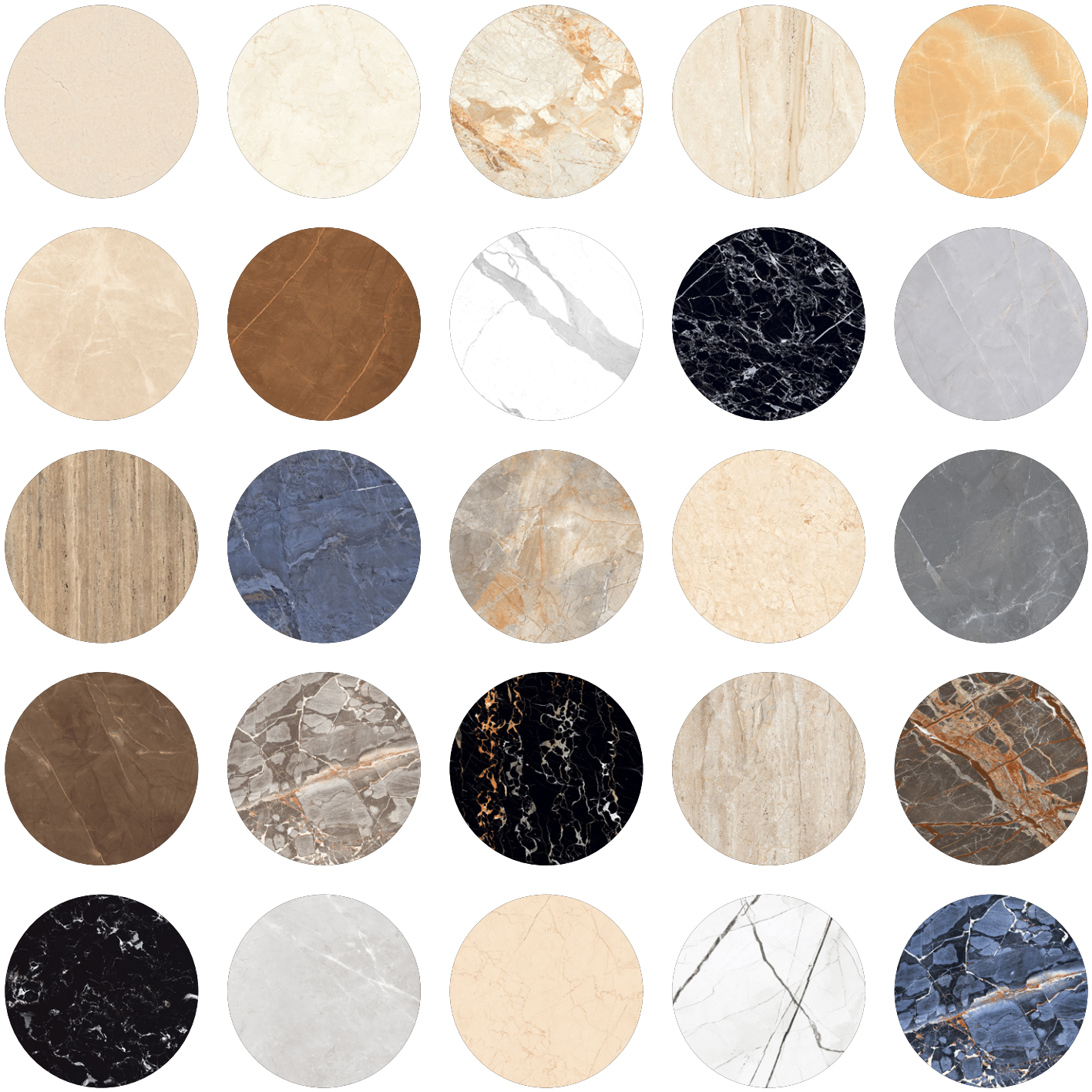

Smart Marble is a flourishing centre for Italian design and slabs. Smart Marble is a new conglomerate that offers a rich array of products and services in terms of design and manufacturing of slabs. Smart Marble represents unparalleled technical, artistic and organizational standards that distinguish it from its peers.

Smart Marble is the essence of years of rigorous research. In its core efforts, Smart Marble epitomizes the urge to establish new standards and norms in the industry. Over decades of experience has gone into the making of this ambitious venture that us set to revolutionize art and craft of manufacturing slabs. Based on ground-breaking research, Smart Marble has conceptualized its ravishing designs and world-class manufacturing process.

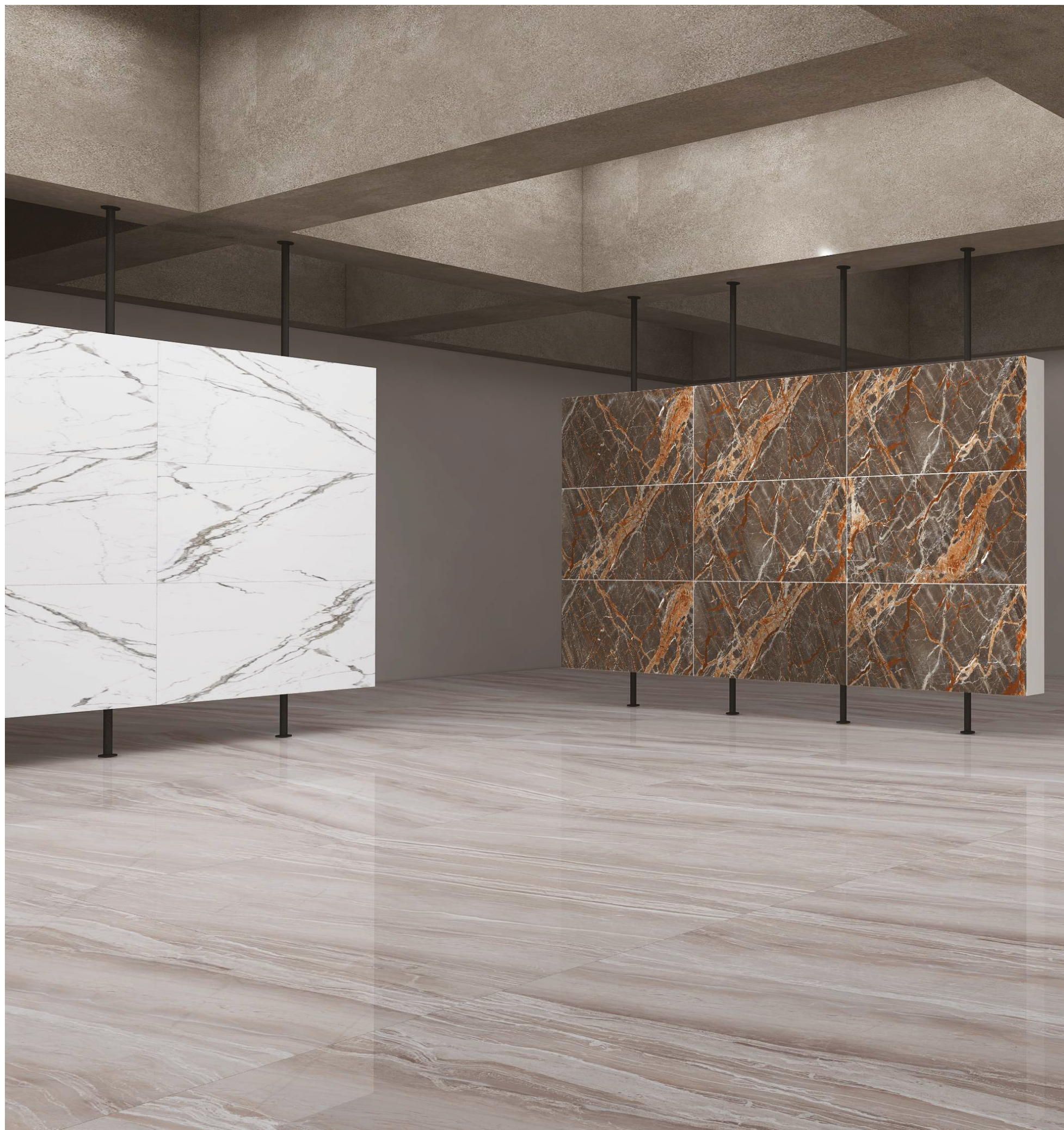



WHAT IS **SMART MARBLE?**

**STRENGTH PLUS
LIGHTNESS,
VERY LARG SIZES
AND LOW THICKNESS.**

An innovative and Italian quality porcelain slabs, ideal for kitchen countertops, bathroom countertops, furniture, flooring and wall applications. The perfect combination of quality and wide collections of texture surface like marble, stone, wood, metal & concrete.

><
6 MM
0.24"

><
9 MM
0.36"



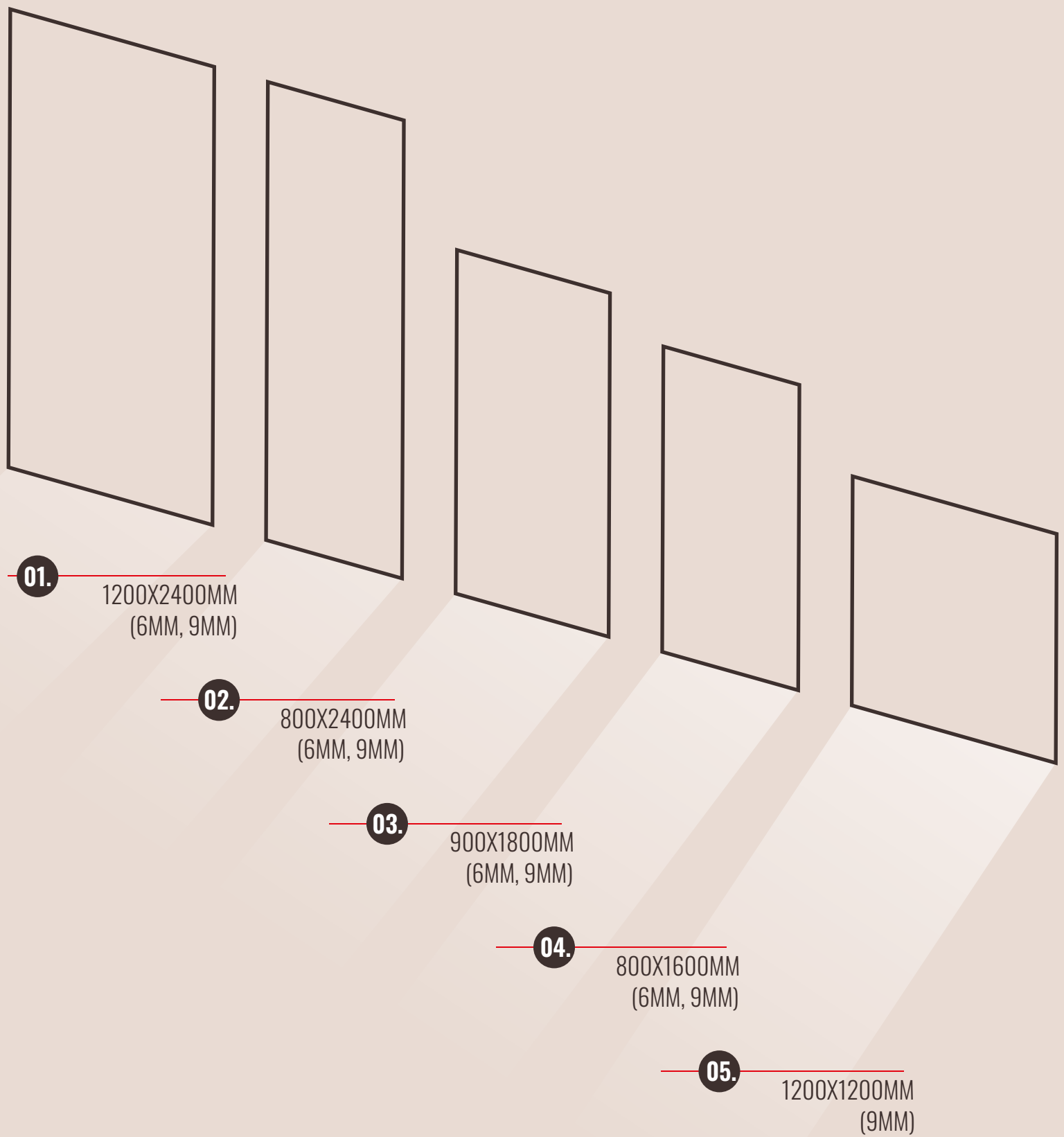

Specific answers to any need.
5 sizes, 2 thickness options

APPLICATION



AIRPORT



RESTAURANT



FITTED KITCHEN AND
BATHROOM FURNITURE



HOTELS



RETAIL MALLS



SPA AND WELLNESS
CENTRES



OFFICES



SHOPS



MUSEUMS



VENTILATED CURTAIN
WALLS



HOMES



INTERIOR DESIGN
AND FURNISHINGS

NEW PRODUCTION TECHNOLOGIES BRING UP THE CHALLENGE OF CREATING MATERIALS CAPABLE OF SHAPING THE SPACE TECHNICALLY AND ESTHETICLY IN AN EFFICIENT WAY.

Smart Marble, a brand born to provide advanced solutions to architecture and interior design. Materials that offer unlimited versatility in all fields of construction, furniture, design, etc.

FEATURES



HIGHLY UV
RESISTANT



RESISTANT TO
SCRATCHES



WATERPROOF



RESISTANCE TO
CHEMICAL ATTACK



LIGHTNESS



LIGHTNESS



FROST
RESISTANCE



RESISTANT TO
STAINS



RECYCLABLE



EASY TO CLEAN



FIREPROOF

POSSIBILITIES

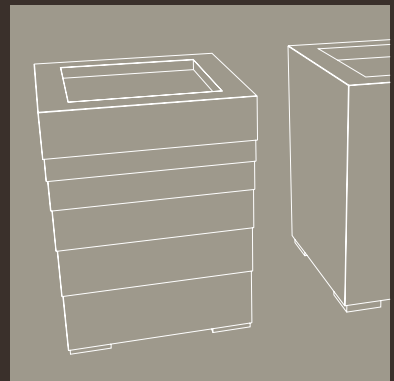
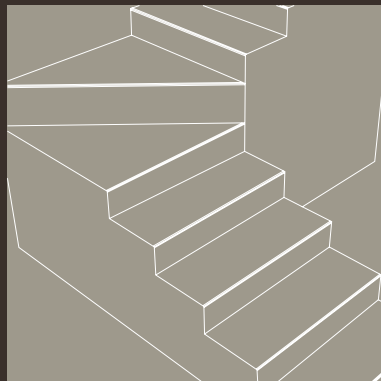
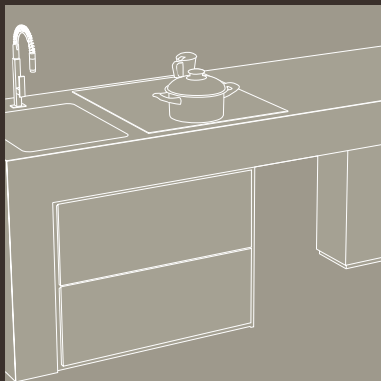
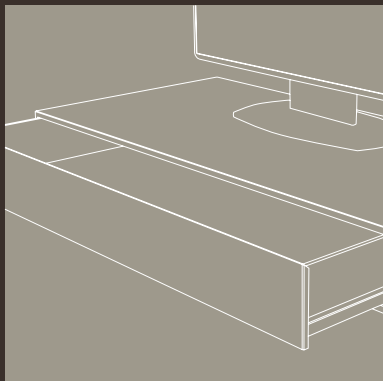
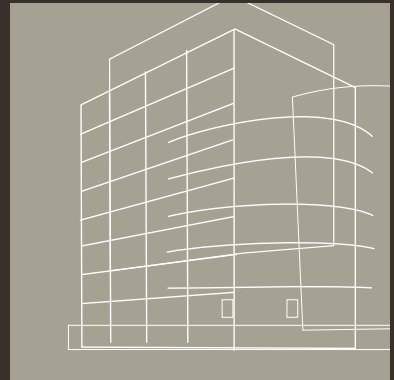
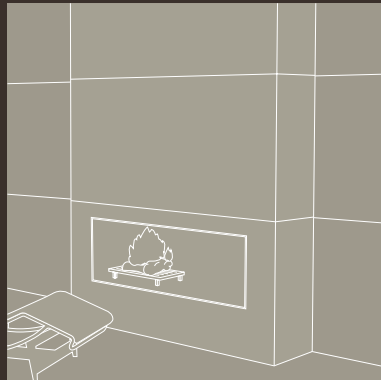
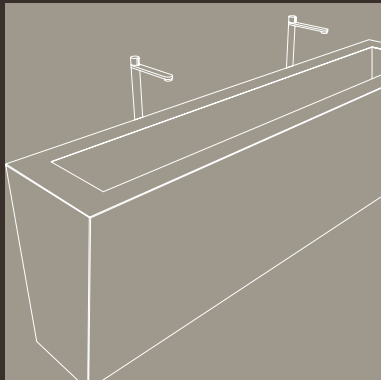
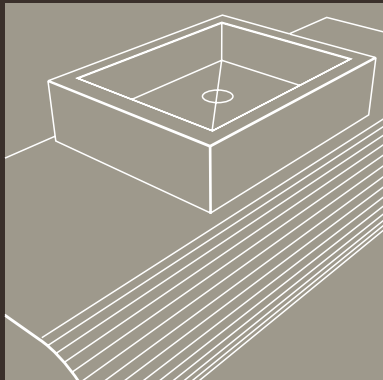
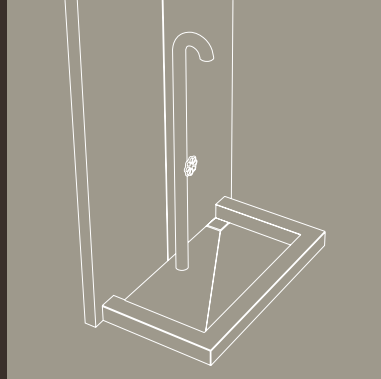
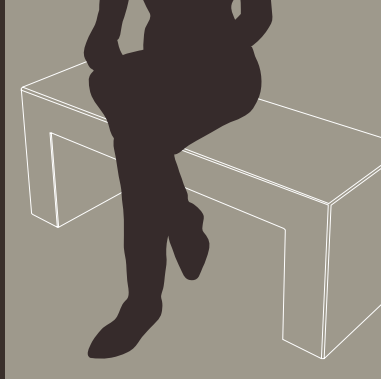
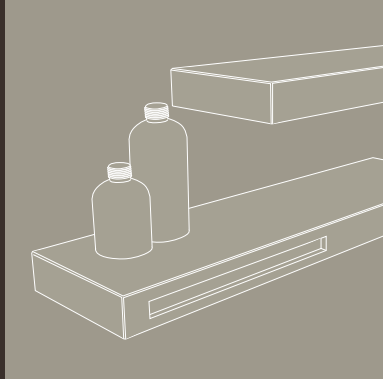

**ORIGINALITY
IS MUST.**



VISIONARY DESIGN

Smart Marble is the perfect combination of visionary design and technological performance, a creative partner anywhere in the world for any type of architectural project requiring distinction through unique, recognizable style.

INNOVATION FOR TOP ARCHITECTURE

Smart Marble stands for innovation that elevates architecture to a rare art form. It leverages design features in such a fashion that architects are able to unleash their creativity and give shape to spaces in an unhindered way. Ibis provides unparalleled innovation quotient for architecture to flourish.

INDUSTRIAL EXPERTISE FOR TECHNICAL PERFECTION

From inception of an idea to manufacturing it to perfection, Ibis possesses staggering industrial expertise for technical excellence. At Ibis, excellence is the only standard that we maintain.

INSPIRING DESIGNERS

The visionary design philosophy propels us towards the consortium of designers who are looking to push the frontiers of design. We collaborate with designers of international repute and provide the impetus for their design aspirations.



FINISH



GLOSSY ROCKER



Different tones of cream, in line with warmer personalities. You can have beautiful spaces that embrace and create a home. We have marbles with great decorative possibilities that never fail. Some are calmer, other are more innovative. They are all beautiful and create a great range of radiant begies that shine with their own light.



CANVAS WOOD GREEN

RANDOM

2



CANVAS WOOD GREY

RANDOM

2



THICKNESS

6MM, 9 MM
15MM, 18MM

SIZE

1200X2400MM

FINISH

GLOSSY
CARVING

EFFECT

MARBLE

MERLIN BEIGE

RANDOM

MERLIN BROWN

RANDOM

4

4



THICKNESS

**6MM, 9 MM
15MM, 18MM**

SIZE

1200X2400MM

FINISH

**GLOSSY
CARVING**

EFFECT

MARBLE

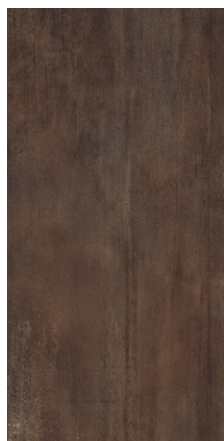

MERLIN CREMA

RANDOM

MERLIN GREY

RANDOM

4

4



THICKNESS

**6MM, 9 MM
15MM, 18MM**

SIZE

1200X2400MM

FINISH

**GLOSSY
CARVING**

EFFECT

MARBLE

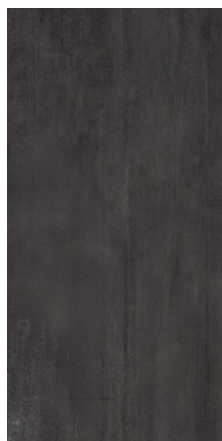
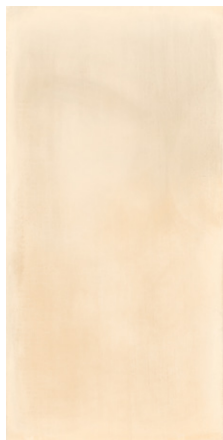
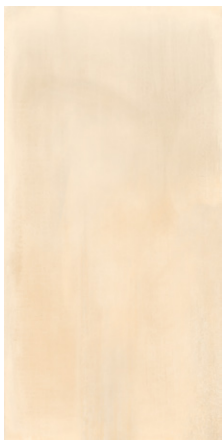

MERLIN NATURAL

RANDOM

MERLIN NERO

RANDOM

4

4



THICKNESS

6MM, 9 MM
15MM, 18MM

SIZE

1200X2400MM

FINISH

GLOSSY
CARVING

EFFECT

MARBLE

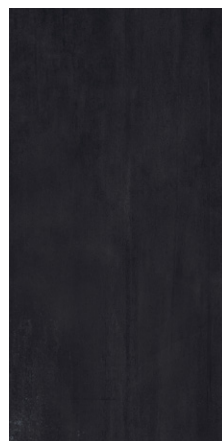
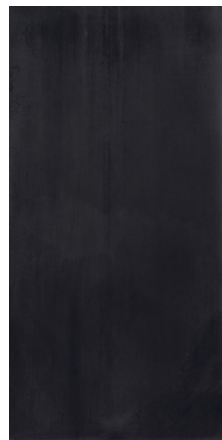

VOLCANO BEIGE

RANDOM

3



VOLCANO CHOCO

RANDOM

3



THICKNESS

**6MM, 9 MM
15MM, 18MM**

SIZE

1200X2400MM

FINISH

**GLOSSY
CARVING**

EFFECT

MARBLE

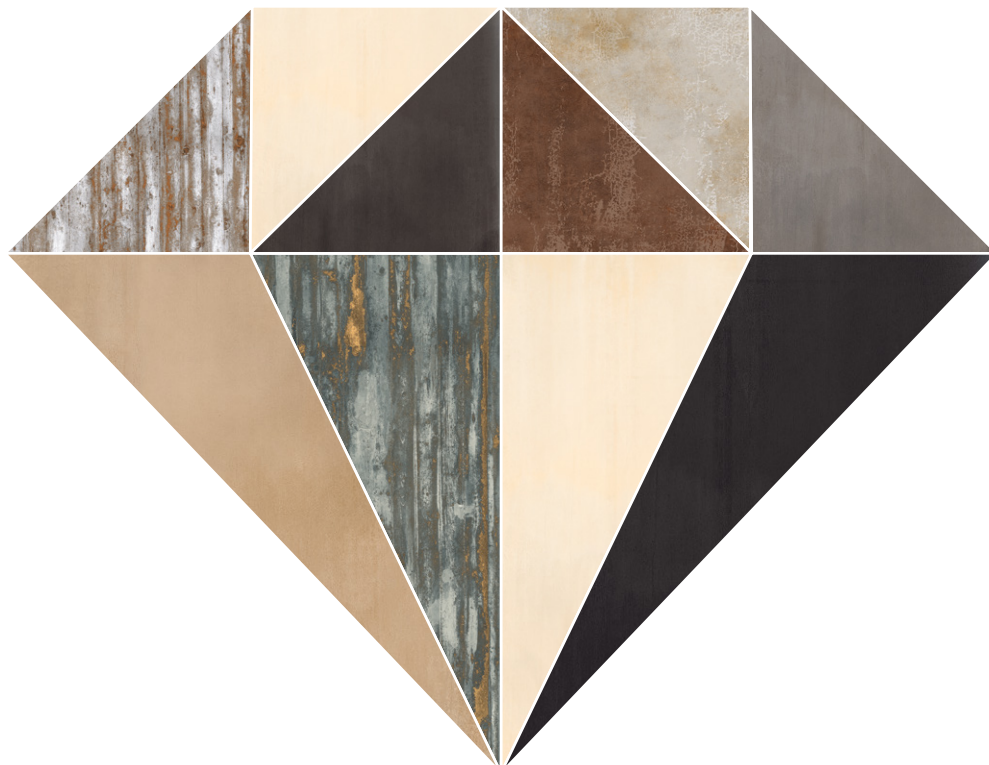

FINISH



MATT ROCKER



Different tones of cream, in line with warmer personalities. You can have beautiful spaces that embrace and create a home. We have marbles with great decorative possibilities that never fail. Some are calmer, other are more innovative. They are all beautiful and create a great range of radiant begies that shine with their own light.



ANCIENT OAK WOOD

RANDOM

2



OXIDO BROWN

RANDOM

5



THICKNESS

6MM, 9 MM
15MM, 18MM

SIZE

1200X2400MM

FINISH

MATT
CARVING

EFFECT

MARBLE



BURMA COFFEE

RANDOM

2



BURMA GOLDEN TEAK

RANDOM

2



THICKNESS

**6MM, 9 MM
15MM, 18MM**

SIZE

1200X2400MM

FINISH

**MATT
CARVING**

EFFECT

MARBLE

SODALITE ANTHRACITE

RANDOM

2

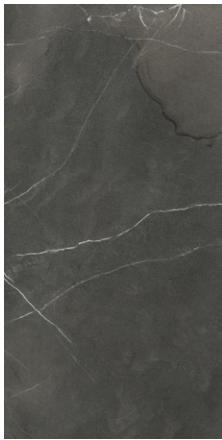

SODALITE BEIGE

RANDOM

2



THICKNESS

6MM, 9 MM
15MM, 18MM

SIZE

1200X2400MM

FINISH

MATT
CARVING

EFFECT

MARBLE

SODALITE BIANCO

RANDOM

2

SODALITE BROWN

RANDOM

2

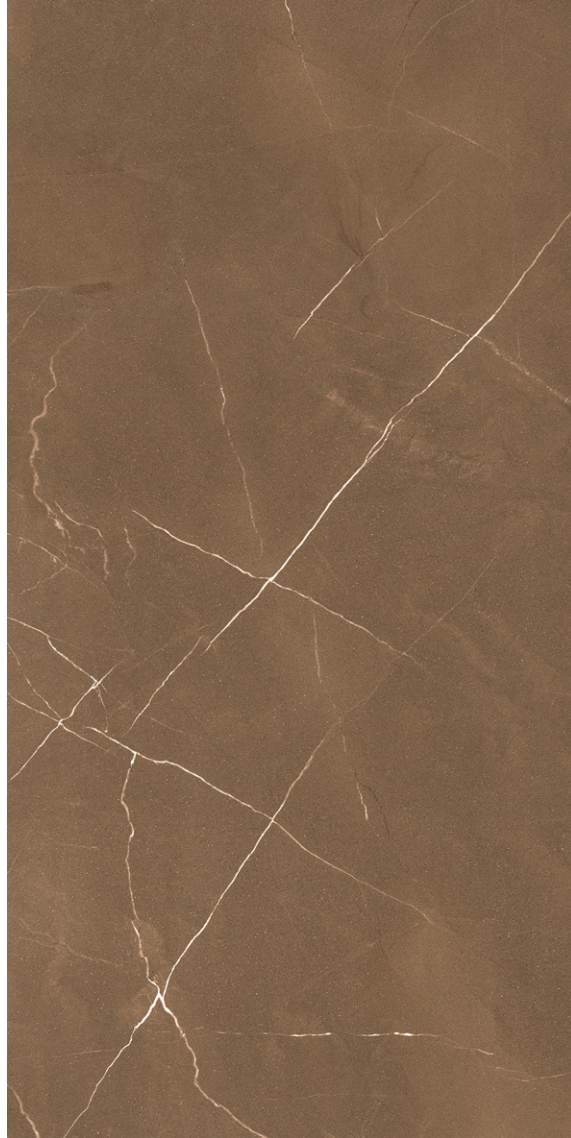

THICKNESS

6MM, 9 MM
15MM, 18MM

SIZE

1200X2400MM

FINISH

MATT
CARVING

EFFECT

MARBLE

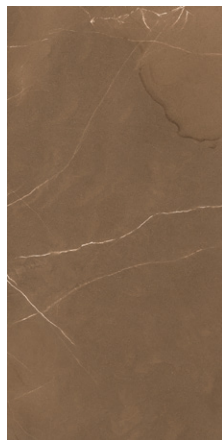

SODALITE DOVE

RANDOM

2

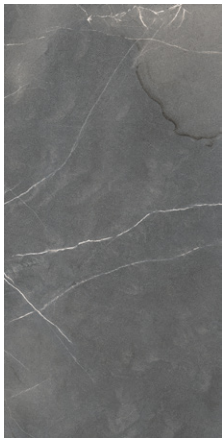

SODALITE GREY

RANDOM

2

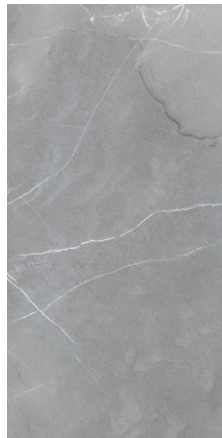

THICKNESS

6MM, 9 MM
15MM, 18MM

SIZE

1200X2400MM

FINISH

MATT
CARVING

EFFECT

MARBLE

WALNUT BROWN

RANDOM

2



WALNUT DARK

RANDOM

2



THICKNESS

6MM, 9 MM
15MM, 18MM

SIZE

1200X2400MM

FINISH

MATT
CARVING

EFFECT

MARBLE

TECHNICAL SPECIFICATION

CHARACTERISTICS	STANDARD AS PER ISO-13006/En14411 GROUP	VALUES	TEST METHOD
-----------------	--	--------	-------------

REGULATORY PROPERTIES

Deviation in Lenth & Width	0.50%	0.20%	ISO - 10545-2
Deviation in Thickness	0.50%	0.50%	ISO - 10545-2
Straightness of Sides	0.50%	0.20%	ISO - 10545-2
Rectangularity	0.50%	0.20%	ISO - 10545-2
Surface Flatness	0.50%	0.20%	ISO - 10545-2
Color Difference	Unaltered	No Change	ISO - 10545-16
Glossiness	As per Mfg.	>90%	Glossmeter

STRUCTURAL PROPERTIES

Water Absorption	<0.05%	<0.05%	ISO - 10545-3
Apparent Density	>2.00 g/cc	>2.10 g/cc	DIN 51082

MASSIVE MECHANICAL PROPERTIES

Modulus of Repture	Min 35N/MM2	Min 40N/MM2	ISO - 10545-4
Breaking Strength	Min. 1300 N	Min. 2000 N	ISO - 10545-4
Impact Resistance	As per Mfg.	Min. 0.55	ISO - 10545-5

SURFACE MECHANICAL PROPERTIES

Surface Abrasion Resistance	As per Mfg.	Min. class 3	ISO - 10545-7
Moh's Hardness	As per Mfg.	Min. class 4	EN 101

THERMO HYGROMETRIC PROPERTIES

Frost Resistance	No Damage	No Damage	ISO - 10545-12
Thermal Shock Resistance	No Damage	No Damage	ISO - 10545-09
Moisture Expansion	Nil	Nil	ISO - 10545-10
Thermal Expansion	Max 9.0x10 ⁻⁶	Max 6.5x10 ⁻⁶	ISO - 10545-08
Crazing Resistance	As per Mfg.	Min 10 Cycle	ISO - 10545-11

CHEMICAL PROPERTIES

Chemical Resistance	No Damage	No Damage	ISO - 10545-13
Stain Resistance	Resistant	Resistant	ISO - 10545-14

SAFETY PROPERTIES

Slip Resistance	As per Mfg.	>0.40	ISO - 10545-17
Fire Resistance	As per Mfg.	Fire Proof	N.A.

PACKING DETAIL

SIZE (in mm)	THICKNESS APPROX	PIECES / PER BOX	COVERAGE AREA IN SQ. FT	BOX WEIGHT (APPROX.)
1200x2400 MM	6 MM	1	31	42
1200x2400 MM	9 MM	1	31	61

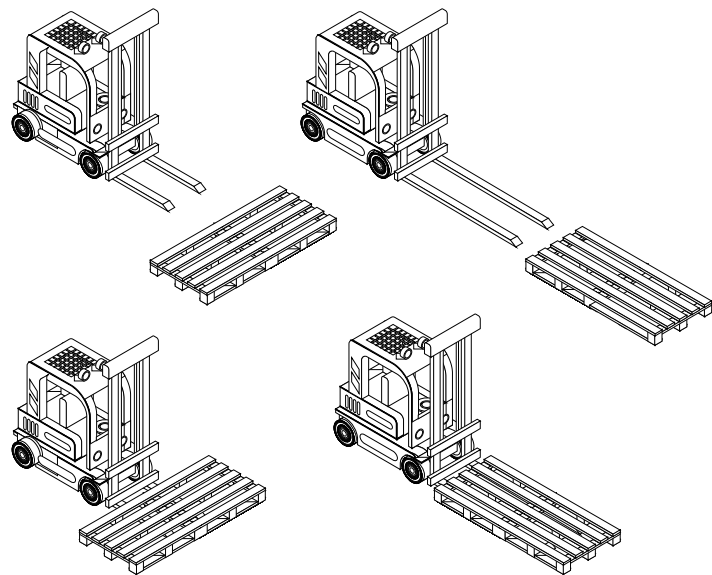

✓ RIGHT

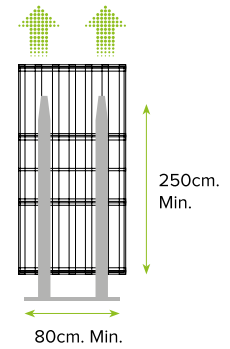
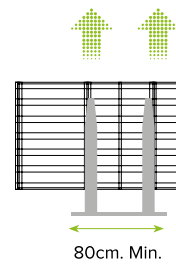
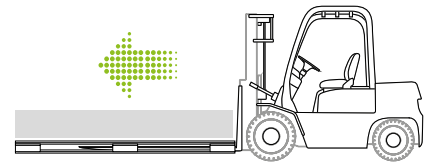

✗ WRONG

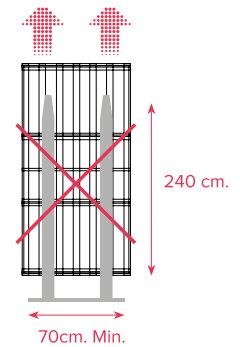
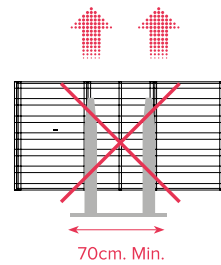
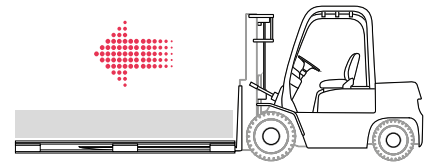

STORAGE

We should use a forklift truck, at least 2,5 mts. long, with the forks positioned in the largest width position, in order to handle the pallet on a proper way. Under normal conditions, the forks are positioned in the middle of the long side of the pallet, as they must hold the whole depth of the pallet. To allow the extraction of the slabs in a safe and easy way, it is recommended to position the pallets in a suitable area where the lift truck can be moved around all sides of the pallet.

HANDLING SLAB

IBIS's Extra large format slabs arrive in oversized crates, which require specific handling equipment. To prevent damage from occurring during forklift operation, specific fork sizes must be used. For example, to handle a crate of 135cm x 305cm tiles from the side, 112cm/ 44" long forks are recommended.

To handle the same crate from the narrow end requires forks that are at least 213cm/ 84" long. Lifting multiple crates with longer forks may require forklifts with a greater lift capacity.

Specialised tools and equipment are currently available for the handling and installation of large porcelain surfaces. Innovative trowels with unique notch configurations can help increase the consistency of the mortar coverage on the back of the tile.

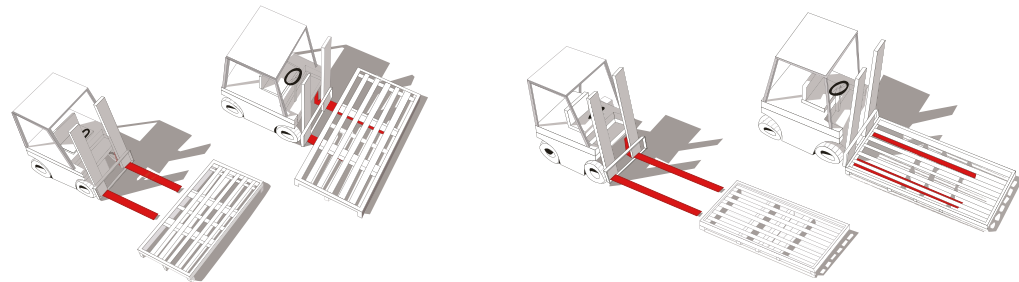

HANDLING EQUIPMENT

Handling device to free move 150X150 Slabs (use 2 for 305cm Slab)



Double Suction Cup 115 MM



Modular Bench BM 180



LEVELLING EQUIPMENT

RLS Clips for Tiles 10-12 MM thick (½" - ¾") - 400 pcs bag

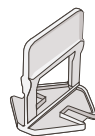

Wedges in 1000 pcs / carton

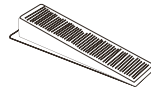

Adjustable pliers for wall and floor covering



CUTTING EQUIPMENT

Free cut guide with complete outfit Max. cut of length-156 CM



Free cut extension length - 170 CM



Cutting of pillars for tiles/slabs Thickness 6-12 MM

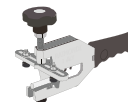

MECHANICAL FIXING EQUIPMENT

Fix Stainless Steel Hook for 8 MM thickness tiles - 500 pcs

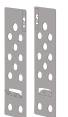

Cut Grooving Machine 850w-230v 50/60hz

